

Table of Contents

Introduction	2
Certifications and qualifications	4
Cable and Accessories	5
Cable components	5
Flat travelling cable	6 - 10
Festoon cable	11
Data cable	12
Flat travelling cable hardware	13 - 14
Flat travelling cable installation instructions	15 - 20
Super-Flex® round steel-supported travelling cable	21 - 23
YSLTK-JZ travelling cable	24
Round travelling cable hanging hardware	25 - 28
Power cable	29 - 36
PVC wireway	37
WAGO connectors	38
Wire Rope, Compensation Cable and Accessories	39
Metric wire rope from BruntonShaw	39
Metric wire rope from Gustav Wolf	40 - 41
Wedge sockets and isolation bushings	42 - 43
Guide rail clips	44
Acculube™ automatic lubricators and DrakaLube® lubricant	45
Rope tensioning systems	46 - 47
Load weighing devices	48 - 49
Compensation comparison	50
Whisper-Flex® compensation cable and pullout switch	51
Steady-Flex® compensation cable	52
Whisper and Steady-Flex kits	53
QuietLink II™ compensation cable	54
QuietLink II kits	55
Easy-Balance™ compensation cable and kit	56
Damping devices	57
Lubricants	58
Components and Systems	59
Event Monitoring Device seismic detector	59
Cabin and shaft communications systems and accessories	60 - 63
Connectorization Services	64

Draka Elevator

DEDICATED TO SERVING THE ELEVATOR INDUSTRY

For more than 35 years, Draka Elevator has been building a global reputation for providing our customers with elevator components that meet their diverse needs. OEMs, installers and mechanics know that we understand their business and strive to meet their expectations for cost, quality and delivery.

Draka Elevator focuses on responding to the challenges presented by you and your latest project. And while our core business is cable, we are constantly evaluating new products and services. Our goal is to provide you with the ways to make your next job faster, safer and less expensive.

Toward this goal, we offer time-saving services like cable connection, cutting-to-length and cable stripping.

Every Draka cable is the result of years of on-the-job experience. Every product we offer is rigorously tested before we let it be sold. And we back our portfolio of products with logistical support from locations in Italy, the Czech Republic, Turkey and the rest of the world.

Consistent. Competent. Compliant. That's who we are at Draka Elevator.

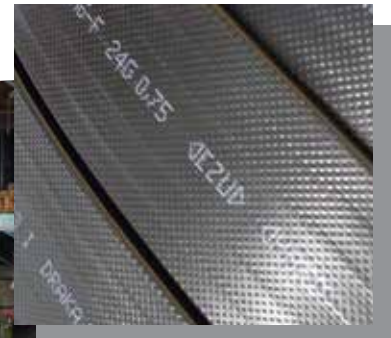

Selection and quality

MEETING STANDARDS ISO 9001:2009 / ISO14001:2004 / ISO18001:2009 / ISO16949:2009

Draka offers a complete product portfolio including flat travelling cables that merit the prestigious ECU HAR conformity mark and the EN 50214 standard in our facility in Velke Mezirici, Czech Republic. This most modern of facilities has passed TÜV quality audits conforming to ISO 9000 and 14001. These include ISO18001:2009 and ISO16949:2009.

Innovation also comes from Velke Mezirici. For instance, our flat cables can be made to your specifications, including elements like special jacket and insulation colours, or signal pairs with braided or aluminum/polyester shields.

Total custom capability

Draka also offers an extensive custom capability. Product suggestions can start with an engineering drawing, a quick sketch or something as simple as a phone call from a customer asking for specific combinations of power and

signal conductors. We can either modify existing designs to fit your needs or create the tooling necessary to build your custom cable. Custom metre-marking is available as well.

We take the extra steps

Our cables and wire ropes can be shipped as a full reel or in cut-to-length spools. We also offer a complete connectorization service complemented with full installation kits and an unparalleled logistics network for fast delivery.

Draka also offers a complete selection of compensation chains, load weighing devices, wire ropes and associated installation components.

Doing whatever it takes to be your supplier

At Draka, we are here to exceed the customer's expectations. Whatever your needs, Draka is ready to be your elevator product supplier.



Proven to meet the performance standards

HAR AND GOST CERTIFICATION

EN 50214 tests and standards

EN 50214 is a European standard maintained by CEN (European Committee for Standardization) and CENELEC. It specifies minimum parameters in nine categories (electrical performance, dimensional characteristics, mechanical properties, bending and impact resistance, etc.). To be used commercially, a flat travelling cable must meet EN 50214 standards.

Complete EN 50214 Testing Results

Test	Requirement	Observed
Cable		
Cable Designation	H05VVH6-F	
Rated voltage	300/500volts	
Construction	24 conductors 0,75 mm ² stranded CU	
Electrical test		
1.1 Max resistance of conductors (ohms/km)	26	25,6
1.2 Voltage test of complete cable at 2000VAC	Pass	Pass
1.3 Voltage test on cores at 1500VAC	Pass	Pass
1.4 Minimum insulation resistance @70°C	0,011	1,05
1.6 Absence of faults	Pass	Pass
Constructional and dimensional characteristics		
2.1 EN 50214 compliance with constructional provisions		24 x 0,75 mm ²
2.2 Measurement of insulation thickness (mm) (min)	0,6	0,67
2.3 Measurement of web thickness (mm) (min)	0,5	0,85
Measurement of top thickness (mm) (min)	0,8	0,89
Measurement of bottom thickness (mm) (min)	0,8	0,94
Measurement of ends (mm) (min)	1,2	1,55
Mechanical properties of insulation		
3.1 Tensile strength before aging (N/mm ²) (min)	10	11,5
Tensile strength after aging (N/mm ²) (min)	10	11,4
Maximum variance	20%	0,80%
Elongation before aging (min)	150%	180
Elongation after aging (min)	150%	200
Maximum variance	20%	11,10%
3.2 Loss of mass (mg/cm ²) (max)	2 mg/cm ²	0,25 mg/cm ²
Mechanical properties of sheath		
4.1 Tensile before aging (N/mm ²) (min)	10	12,5
Tensile after aging (N/mm ²) (min)	10	11,3
Maximum variance	20%	9,6%
Elongation before aging (min)	150%	250
Elongation after aging (min)	150%	210
Maximum variance	20%	16%
4.2 Loss of mass (mg/cm ²) (max)	2 mg/cm ²	0,33 mg/cm ²
Pressure test at high temperatures		
5.1 Insulation (max)	50%	18%
5.2 Sheath (max)	50%	34%
Bending and impact test at low temperatures		
6.1 Bending test for insulation	No cracks	No cracks
6.2 Bending test for sheath	No cracks	No cracks
6.3 Elongation test for insulation @15°C (min)	30%	130%
6.4 Elongation test for sheath @15°C (min)	30%	87%
6.5 Impact for insulation	No cracks	No cracks
6.6 Impact for sheath	No cracks	No cracks
6.7 Unrolling at low temperature @-20°C	1 minute	1 minute
Heat shock test		
7.1 Insulation	No cracks	No cracks
7.2 Sheath	No cracks	No cracks
Mechanical properties of complete cable		
8.1 Static flexibility (mm) (max)	700	304
8.2 Flexing test @400VAC	30.000	30.000
1500VAC after flexing	Pass	Pass
8.3 Adherence test between sheath and conductors (min)	3	18

HAR certificate



GOST certificate



EN 50214 Reverse Bend Flex Test

EN 50214 specifies a severe mechanical test for flat PVC sheathed flexible cables - the reverse bend flex test. In this test, the cable ends are weighted with 10 times the weight of a one meter sample. A pulley rig traverses a specified distance forcing the cable sample into a moving reverse bend. Current is applied to each conductor so that if a conductor opens, the flexing operation will stop. The cable must endure 30,000 cycles. Draka flat cables exceed this requirement.

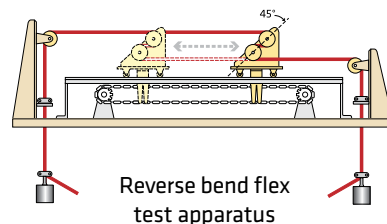

Technical parameters, options and components

CUSTOM CABLE CONSTRUCTIONS ARE OUR SPECIALTY

Draka travelling cables are available in custom configurations. These can include:

- Steel supports
- Specially formulated compounds for shielded data pairs meeting CANBUS impedance requirements
- Coaxial cable (75Ω) for CCTV monitoring or high resolution video
- Special color-coding and on-line marking for insulation and jacketing
- Unitized subgroups for configurations above 34 components
- Optical multimode fiber components (OM2/OM3)
- Multiple shielding variants (aluminum covered foil or tinned copper braid)
- For any travelling speeds and heights including mining or panoramic elevators
- Other international standards (UL/CSA/GBT)

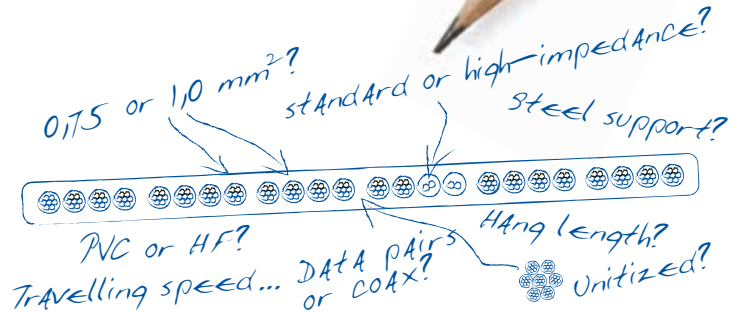

Construction

Flexible bare copper conductor, class 5 according to IEC 60228

Insulation is polyolefin compound FRLSHF (halogen free), special PVC insulation according to HD21.1, optional PVC flexible to -30°C

Cores are laid in parallel and covered with the outer sheath. Sheath does not stick to the cores.

Outer sheath is special PVC insulation according to HD21.1, optional PVC flexible to -30°C or polyolefin compound FRLSHF (halogen free)

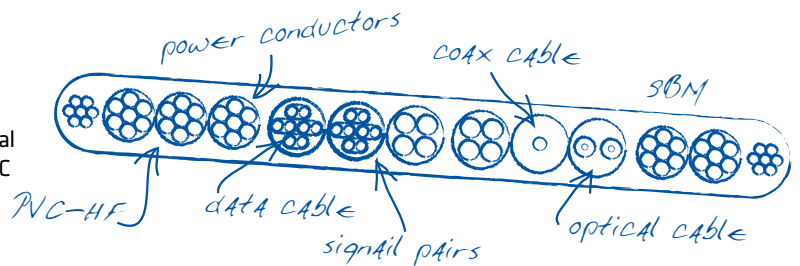

Technical specifications

- Nominal voltage: 300/500 V
- Test voltage: 2 kV
- Perm. operating temperature: min. -15 °C max. +70 °C
- Min. bending radius: 25 x cable height
- Sheath colour: Black RAL 9005

Not recommended for use outdoors.

Flat cable travelling speeds do not exceed 4 m/s for unsupported and 12 m/s for supported constructions. Unsupported cables have up to 45 m free suspended length - see specification for supported cable suspended length. NOTE: Maximum free suspension length is the distance between two fixed points (i.e. hanging devices on wall and cab).

Colour marking of cores according to:

- White cores numbered + 1 green/yellow according to EN 50334.
- 6 cores: green/yellow between numbers 2 and 3
- > 6 cores: green/yellow between numbers 7 and 8

Marking: DRAKA 07 05ZZH6-F (NxS or NGS) mm², where N = Number of conductors and S = Cross-section. Metre marking and "Made in EU" text is standard. Draka's internal order number is used to trace each step of the cable construction.

- Technical specification: according to EN 50214 and PN
- Standard packaging: cables with 20-24 cores on 500 m drums
cables with 6-18 cores on 1000 m drums

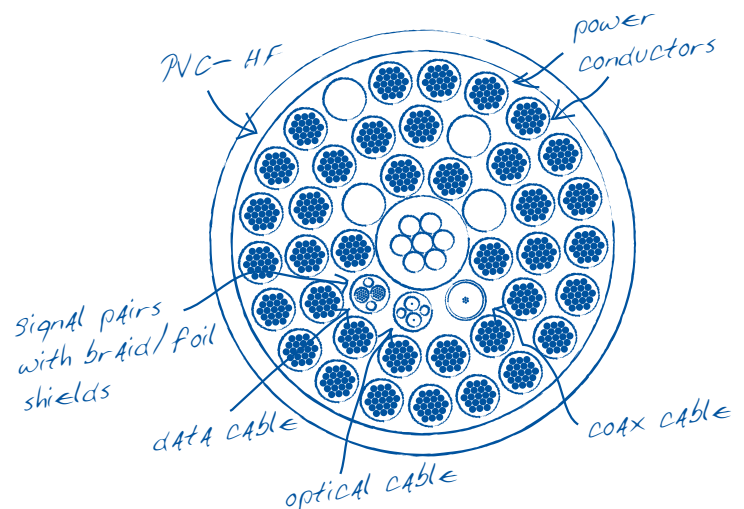

Meets standards for HF and PVC constructions

- Halogen (HF): EN 50267-2-1 / IEC 60754-1
- Low opacity (HF): IEC 61034
- Low corrosivity (HF): EN 50267-2-2 / IEC 60754-2
- Lead free: Atomic absorption test
- Flame retardance (PVC): According to EN 60332-1 (IEC 60332-1)

Flat Travelling Cable / Parallel

UNSUPPORTED / TO MEET EN50214

H05VVH6-F power and signal conductors

Part Number	Cable Construction conductors mm ²	Maximum Free Suspension Length m	Cable Dimension H mm x W mm	Cable Net Weight kg/km (approx.)	Standard Length m
20065525	6x0,75	45	4,1 x 17,5	127,1	1000
20065045	6x1,0	45	4,3 x 19,0	146,9	1000
20107432	8x0,75	45	4,1 x 22,5	164,0	1000
20065601	9x0,75	45	4,1 x 25,5	188,1	1000
20085326	9x1,0	45	4,3 x 27,0	218,1	1000
20065527	12x0,75	45	4,1 x 33,0	243,5	1000
20067120	12x1,0	45	4,3 x 35,0	282,9	1000
20065529	16x0,75	45	4,1 x 43,5	322,9	1000
20065054	16x1,0	45	4,3 x 46,0	375,7	1000
20065041	18x0,75	45	4,1 x 48,0	359,8	1000
20065058	18x1,0	45	4,3 x 51,0	418,9	1000
20065341	20x0,75	45	4,1 x 53,5	402,4	500
20065503	20x1,0	45	4,3 x 57,0	473,6	500
20065532	24x0,75	45	4,1 x 64,0	482,1	500
20065061	24x1,0	45	4,3 x 68,0	561,6	500
20107360	28x0,75	45	4,1 x 74,5	556,4	500
20113443	28x1,0	45	4,3 x 77,5	645,3	500
On request	12x1,0 in additionally-spaced groups	45	4,3 x 39,2	313,3	1000
On request	20x1,0 in additionally-spaced groups	45	4,3 x 66,2	511,5	500
On request	24x1,0 in additionally-spaced groups	45	4,3 x 79,0	639,5	500



05ZZH6-F power and signal conductors / halogen free

Part Number	Cable Construction conductors mm ²	Maximum Free Suspension Length m	Cable Dimension H mm x W mm	Cable Net Weight kg/km (approx.)	Standard Length m
20107447	6x0,75	45	4,1 x 18,0	105,2	1000
20096672	6x1,0	45	4,3 x 19,0	122,8	1000
20122716	8x0,75	45	4,1 x 22,5	136,1	1000
20107449	9x0,75	45	4,1 x 25,5	155,8	1000
20122717	9x1,0	45	4,3 x 27,0	182,0	1000
20107451	12x0,75	45	4,1 x 33,0	202,1	1000
20092132	12x1,0	45	4,3 x 35,0	237,8	1000
20107453	16x0,75	45	4,1 x 43,5	268,1	1000
20122718	1x1,0	45	4,3 x 46,0	314,5	1000
20107100	18x0,75	45	4,1 x 48,0	299,0	1000
20100151	18x1,0	45	4,3 x 51,0	352,5	1000
20107455	20x0,75	45	4,1 x 53,5	334,1	500
20107104	20x1,0	45	4,3 x 57,0	394,0	500
20107461	24x0,75	45	4,1 x 64,0	400,3	500
20065068	24x1,0	45	4,3 x 68,0	472,3	500
20107463	28x0,75	45	4,1 x 74,5	466,5	500
20122725	28x1,0	45	4,3 x 77,5	543,5	500



Glands for H05VVH6-F cables

Part Number	Fits Cable(s)	Opening Size mm
M 25-6/6 x 1(0,75)	6x0,75, 6x1,0	19 x 4,5
M 25-12/12 x 1(0,75)	12x0,75, 12x1,0	34 x 4,5
M 32/18 x 0,75	18x0,75	48 x 4,0
M 32/18 x 1	18x1,0	50 x 4,5
M 40/24 x 0,75	24x0,75	66 x 4,0
M 40/24 x 1	24x1,0	68 x 4,5

Glands for H05VVH6-F cables

Part Number	Fits Cable	Opening Size mm
Pg 21/18 x 0,75	18x0,75	48 x 4,0
Pg 21/18 x 1	18x1,0	50 x 4,5
Pg 29/24 x 0,75	24x0,75	66 x 4,0
Pg 29/24 x 1	24x1,0	68 x 4,5



Custom cables

H05VVH6-F and 05ZZH6-F cables can be ordered:

- with white, gray or black jackets
- custom jacket printing

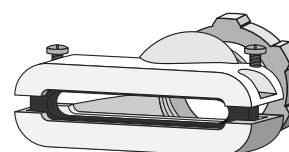

Flat Travelling Cable / Parallel

UNSUPPORTED / TO MEET EN50214

H05VVH6-F power, signal and communication conductors

Part Number	Cable Construction conductors mm ²	Maximum Free Suspension Length m	Cable Dimension H mm x W mm	Cable Net Weight kg/km (approx.)	Standard Length m
On request	2x1,5+8x(2x0,5)+HF75 120Ω pairs have Al/PET foil	45	6,6 x 46,0	483,1	500
20107410	14x0,75+1,5+2x(2x0,5) 80Ω pairs have braided shield	45	5,4 x 51,0	478,4	1000
20107330	16x0,75+2x(2x0,5) 80Ω pairs have braided shield	45	5,4 x 53,5	506,5	1000
20107415	16x0,75+2x(2x0,34) 110Ω pairs have braided shield	45	5,4 x 53,5	515,9	1000
20107417	16x0,75+1,5+1x(2x0,5) 80Ω pair has braided shield	45	5,4 x 51,5	485,4	500
20107351	16G0,75+8x0,50	45	4,1 x 61,5	454,0	500
20065036	20x0,75+2x(2x0,5) 80Ω pairs have braided shield	45	5,4 x 63,0	613,6	500
20118060	20x0,75+2x(2x0,34) 110Ω pairs have braided shield	45	5,4 x 63,0	625,2	500
20107332	22x0,75+2x(2x0,5) 80Ω pairs have braided shield	45	5,4 x 65,0	629,6	500
20099839	24x0,75+2x(2x0,5) 80Ω pairs have braided shield	45	5,4 x 74,5	710,8	500
20122729	24x1,0+4x(2x0,5) 80Ω pairs have braided shield	45	5,4 x 84,0	855,4	500
20122730	28x0,75+4x(2x0,34) 100Ω pairs have AL/PET foil shielding	45	5,4 x 86,5	748,6	500
20099838	28x0,75+2x(2x0,5) 80Ω pairs have braided shield	45	5,4 x 84,5	804,4	500
20099835	30x0,75+2x(2x0,5) 80Ω pairs have braided shield	45	5,4 x 89,0	865,6	500



05ZZH6-F power, signal and communication conductors / halogen-free

Part Number	Cable Construction conductors mm ²	Maximum Free Suspension Length m	Cable Dimension H mm x W mm	Cable Net Weight kg/km (approx.)	Standard Length m
20122719	16x0,75+2x(2x0,5) 80Ω pairs have braided shield	45	5,4 x 51,5	485,4	500
20122720	16x0,75+2x(2x0,34) 110Ω pairs have braided shield	45	5,4 x 53,5	425,7	500
20107464	20x0,75+2x(2x0,5) 80Ω pairs have braided shield	45	5,4 x 63,0	509,4	500
20118061	20x0,75+2x(2x0,34) 110Ω pairs have braided shield	45	5,4 x 63,0	517,6	500
20122722	22x0,75+2x(2x0,5) 80Ω pairs have braided shield	45	5,4 x 65,0	518,3	500
20122724	24x0,75+2x(2x0,5) 80Ω pairs have braided shield	45	5,4 x 74,5	585,7	500
20122723	24x1,0+4x(2x0,5) 80Ω pairs have braided shield	45	5,4 x 84,0	720,3	500
20122726	28x0,75+2x(2x0,5) 80Ω pairs have braided shield	45	5,4 x 84,5	662,3	500
20122727	28x0,75+4x(2x0,34) 110Ω pairs have AL/PET foil shield	45	5,4 x 86,5	622,9	500
20122728	30x0,75+2x(2x0,5) 80Ω pairs have braided shield	45	5,4 x 89,0	715,0	500



All communications pairs are tested at 100 kHz for impedance and attenuation

Flat Travelling Cable / Parallel

STEEL SUPPORTED / TO MEET EN50214

H05VVD3H6-F power and signal conductors

Part Number	Cable Construction conductors mm ²	Steel Support Diameter mm	Maximum Free Suspension Length m	Cable Dimension H mm x W mm	Cable Net Weight kg/km (approx.)	Standard Length m
20102460	24x1,0	2 x 1,8	150	4,3 x 75,0	633,6	500

05ZZD3H6-F power and signal conductors / halogen-free

Part Number	Cable Construction conductors mm ²	Steel Support Diameter mm	Maximum Free Suspension Length m	Cable Dimension H mm x W mm	Cable Net Weight kg/km (approx.)	Standard Length m
on request	24x1,0	2 x 1,8	150	4,3 x 75,0	540,0	500

H05VVD3H6-F power, signal and communication conductors

Part Number	Cable Construction conductors mm ²	Steel Support Diameter mm	Maximum Free Suspension Length m	Cable Dimension H mm x W mm	Cable Net Weight kg/km (approx.)	Standard Length m
On request	16x0,75+2x(2x0,34) 110Ω pairs have braided shield	2 x 1,8	150	5,4 x 57,0	580.0	1000
20122152	30x1,0+2x(2x0,5) 80Ω pairs have braided shield	2 x 1,8	135	5,4 x 98,0	1030.0	500
On request	5x2,5+10x1+4x(2x0,34) 110Ω pairs have braided shield	2 x 1,8	160	5,4 x 75,0	790.0	500

05ZZD3H6-F power, signal and communication conductors / halogen-free

Part Number	Cable Construction conductors mm ²	Steel Support Diameter mm	Maximum Free Suspension Length m	Cable Dimension H mm x W mm	Cable Net Weight kg/km (approx.)	Standard Length m
on request	16x0,75+2x(2x0,34) 110Ω pairs have braided shield	2 x 1,8	150	5,4 x 57,0	490,0	1000



The 36-135-M1 stripper is the ideal tool for preparing flat cable. Call for details.

Flat Travelling Cable / Parallel

UNSUPPORTED OR STEEL SUPPORTED

FLI-2YS(ST)(C)TH data communication conductors / Cat7 / supported

Part Number	Cable Construction conductors mm ²	Steel Support Diameter mm	Maximum Free Suspension Length m	Cable Dimension H mm x W mm	Cable Net Weight kg/km (approx.)	Standard Length m
20130820	4x(2x0,132) 100Ω pairs have braided shield	2 x 1,8	50	8,0 x 16,6	192,0	500



FLI-2YS(ST)(C)HY data communication conductors / Cat7 / unsupported

Part Number	Cable Construction conductors mm ²	Steel Support Diameter mm	Maximum Free Suspension Length m	Cable Dimension H mm x W mm	Cable Net Weight kg/km (approx.)	Standard Length m
20145350	4x4x(2x0,132) 100Ω pairs have braided shield	n/a	45	8,4 x 32,0	375,0	500



FLI-9Y(C)Y data communication conductors

Part Number	Cable Construction conductors mm ²	Steel Support Diameter mm	Maximum Free Suspension Length m	Cable Dimension H mm x W mm	Cable Net Weight kg/km (approx.)	Standard Length m
On request	4x(2x0,75)+HF75 90Ω pairs have braided shield 75Ω 0,6 mm coax conductor	n/a	35	7,6 x 32,5	385	500



FLI-9Y(C)H data communication conductors / halogen free

Part Number	Cable Construction conductors mm ²	Steel Support Diameter mm	Maximum Free Suspension Length m	Cable Dimension H mm x W mm	Cable Net Weight kg/km (approx.)	Standard Length m
On request	4x(2x0,75)+HF75 90Ω pairs have braided shield 75Ω 0,6 mm coax conductor	n/a	35	9,6 x 34,0	410,0	500
On request	12x(2x0,75) 90Ω pairs have foil shield	n/a	35	7,0 x 65,0	530	500



LIFTSCREEN CANbus multimedia cable / halogen free

Part Number	Cable Construction conductors mm ²	Steel Support Diameter mm	Maximum Free Suspension Length m	Cable Dimension H mm x W mm	Cable Net Weight kg/km (approx.)	Standard Length m
20133797	4x2xAWG26/7+1,2/4,95-75Ω+ (2x2x0,22)C CAN	2,8	80	8,5 x 35,0	410	500



Flat Travelling Cable / Unitized

UNSUPPORTED OR STEEL SUPPORTED AS NOTED

05VVH6-F power, signal and communications

Part Number	Cable Construction conductors mm ²	Steel Support Diameter mm	Maximum Free Suspension Length m	Cable Dimension H mm x W mm	Cable Net Weight kg/km (approx.)	Standard Length m
On request	2x(4x0,75)+4x(2x0,75)+1HF75 90Ω pairs have Al/PET foil shield 75Ω 0,6 mm coax conductor	n/a	45	8,2 x 44,0	510,0	500

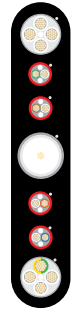

05ZZH6-F power, signal and communication conductors

Part Number	Cable Construction conductors mm ²	Steel Support Diameter mm	Maximum Free Suspension Length m	Cable Dimension H mm x W mm	Cable Net Weight kg/km (approx.)	Standard Length m
On request	2x(4x0,75)+4x(2x0,75)+1HF75 90Ω pairs have Al/PET foil shield 75Ω 0,6 mm coax conductor	n/a	45	9,2 x 46,2	601,0	500

D05VE7C4VH6-F power, signal and communications

Part Number	Cable Construction conductors mm ²	Steel Support Diameter mm	Maximum Free Suspension Length m	Cable Dimension H mm x W mm	Cable Net Weight kg/km (approx.)	Standard Length m
20134881	7x(5 x 1,0)+(2x2x0,50) 120Ω braided shielded DM quad	n/a	45	9,7 x 50,5	775,0	500

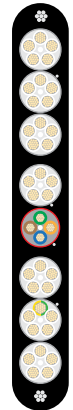

D05VE7C4VD3H6-F power, signal and communications / steel supported

Part Number	Cable Construction conductors mm ²	Steel Support Diameter mm	Maximum Free Suspension Length m	Cable Dimension H mm x W mm	Cable Net Weight kg/km (approx.)	Standard Length m
20134782	7x(5 x 1,0)+(2x2x0,50) 120Ω braided shielded DM quad	2 x 2,8	100	9,7 x 70,5	1.175,0	500

D05Z1E7C4Z1D3H6-F power, signal and communications / steel supported / halogen free

Part Number	Cable Construction conductors mm ²	Steel Support Diameter mm	Maximum Free Suspension Length m	Cable Dimension H mm x W mm	Cable Net Weight kg/km (approx.)	Standard Length m
On request	7x(2x5 x 1,0)+2x(2x0,50) 120Ω braided shielded DM quad	2 x 2,8	100	9,7 x 70,5	1.010,0	500

Cables for Special Applications

PLANOFLEX FESTOON AND PROTOMONT MINE LIFT CABLES

PLANOFLEX (N)GFLGOEU-J/O power and control cables for festoons

PLANOFLEX (NGFLGOEU-J/O) power and control cables are used on festoon systems, connecting movable parts on machine tools, material handling equipment, etc., where flexibility and resistance to mechanical stresses is essential.

PLANOFLEX cables may be used indoors or outdoors. They are resistant to petroleum, ozone, UV and moisture. They meet DIN VDE 0250, part 809, UL-FILE 113313: GOST R. They are recommended for festoon speeds of up to 180 m/min. Please consult with Draka if higher speeds are required.

Construction

Stranded copper conductors 1,5 to 95 mm²

PROTOLON (EPR) insulation

Shield for individually shielded cores and twisted and shielded pairs

Screens are 60 and 80% tinned copper braid

Sheath is PROTOFIRM 5GM3 rubber

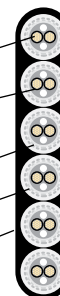

PROTOMONT NTMTWOEU control and communication cables for mine lifts

PROTOMONT (NTMTWOEU) flexible rubber-sheathed cables are used as travelling cable for intrinsically safe control and telephone connections in user-operated mine hoists (lifts) in underground mines.

PROTOMONT cables can be operated as self-supported cables at up to 200 meters in length with a 5x safety factor. They meet DIN VDE 0250 part 812 and MSHA P-189-3

Construction

Steel rope core with rubber covering

Stranded copper conductors 1,8 to 2,6 mm²

PROTOLON (EPR) insulation

Textile anti-torsion braid

Sheath is PROTOFIRM 5GM3 rubber

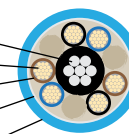

Data and Communication Cable

CATEGORY 7, COAX, CANBUS AND PROFIBUS CABLES

UC900 SS26 Category 7 meeting EN 50173-1 and 50288-4-2 / halogen free

Designation	Type	Colour	Nominal Diameter mm	Fire load MJ/km • kWh/m	Net Weight (approx) kg/km	Standard Length m
Li-02Y5(S+)CH 4x2x0,48 PIMF LSHF	UC900 SS26 Cat7 S/FTP patch 4P LSHF	Gray	6,0	296 • 0,082	37	1000

Features

UC900 Cat7 cables are used for patching and local connection. They can be used for network speeds up to 10 Gb/s (IEEE 10GBase-T).

Halogen-free versions are available

Construction

Stranded copper conductors 0,48 mm with PE insulation

Pairs screened with Al-PET

Overall screen is tinned copper braid

Sheath is LSHF polymer

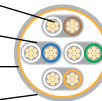

75Ω Coaxial cable / halogen free

Designation	Type	Colour	Nominal Diameter mm	Fire load MJ/km • kWh/m	Net Weight (approx) kg/km	Standard Length m
DRAKA 1.2/4.95 - 75 Ohm	1,2L/4,95AF - 75Ω	Blue	6,5	n/a	50	1000

Features

75Ω coax is used for data and video communication (CCTV).

Attenuation: 0,76 dB/100m @ 1 MHz

6,3 dB/100m @ 100 MHz

17,9 dB/100m @ 800 MHz

Construction

Stranded copper conductors 1,2 mm

Foamed PE dielectric / insulation

Screen is Al-foil and 85% tinned copper braid

Sheath is LSHF polymer

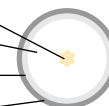

75Ω Small diameter coaxial cable / PVC

Designation	Type	Colour	Nominal Diameter mm	Fire load MJ/km • kWh/m	Net Weight (approx) kg/km	Standard Length m
FLEX 5/75 3623L10	n/a	Gray	4,7	n/a	35,4	1000

Features

75Ω coax is used for patching telecom signals at central offices.

Attenuation: 1,5 dB/100m @ 1,0 MHz

4,7 dB/100m @ 10 MHz

10,0 dB/500m @ 50 MHz

Construction

Stranded copper conductors 0,6 mm

Foamed PE dielectric / insulation

Screens are 90 and 81% tinned copper braid

Sheath is flame-retardant PVC

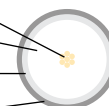

CANbus cable to meet EN 50170, DIN 19245 and ISO 11898-2 / halogen free

Designation	Type	Colour	Nominal Diameter mm	Fire load MJ/km • kWh/m	Net Weight (approx) kg/km	Standard Length m
Li-2YC11Y FRNC	2x2x0,22	Black	6,9	n/a	70	1000

Features

Draka CANbus cables are only used in travelling/hoist cables and meet all standards for CANbus transmission. Their halogen-free and flame retardant construction (EN 50265-2-1) also resists oil, including hydraulic fluid, ARAL VITAM 32, Mobil DTE 13 M, Gear oil ARAL DEGOL BG Plus 320 and Tribol 1710/320.

PROFIBUS cables to meet EN 50170, IEC 61158 and IEC 61784 on request.

Signal pairs

Shielded pairs are available in four sizes:

0,25 mm²

0,34 mm²

0,50 mm²

0,75 mm²

Typical impedance is 80Ω ± 15%.

Versions with 120Ω impedance are available on request.

Construction

Stranded copper conductors 0,6 mm

PE insulation

Screens are 85% tinned copper braid and PET-foil

Sheath is PUR LSHF

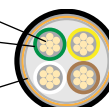

Construction

Class 5 copper conductors in four sizes

PE insulation

Screens are 85% tinned copper braid or Al-PET

Sheath is flame-retardant PVC

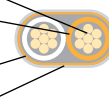

Flat Cable Suspension Devices

FOR UNSUPPORTED FLAT CABLES - NYLON/PLASTIC CONSTRUCTION

Two cable version

Part Number	Description
FCSD-2	Flat cable suspension device for cables up to 52 mm wide Mounting holes are 5 mm with 14 mm counterbore

The FCSD-2 is made of a durable nylon/plastic. It consists of a bracket that attaches to the hoistway wall or the car, and a clamping wedge that secures the cable in the bracket.

The FCSD-2 is designed to hold cables totaling a maximum thickness of 12 mm and maximum width of 252 mm. If multiple cables are being supported, the narrowest width cable must not be less than 70% of the width of the widest cable.

Order two devices per cable, one for the car and one for the hoistway.

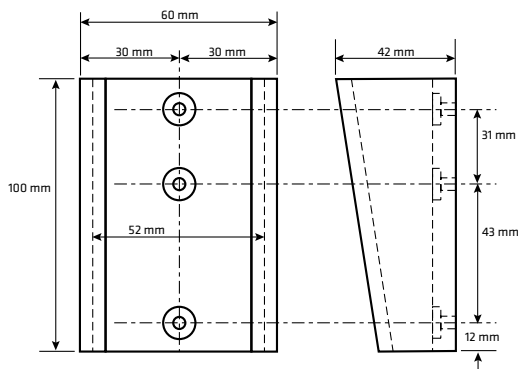

Three cable version

Part Number	Description
FCSD-3	Flat cable suspension device for up to 3 cables, max 76 mm wide Mounting holes are 6,35 mm with 14 mm counterbore

The FCSD-3 is made of a durable nylon/plastic (a metal plate version is available). It consists of a bracket that attaches to the hoistway wall or the car, and a clamping wedge that secures the cable in the bracket.

The FCSD-3 is designed to hold up to three cables totaling a maximum thickness of 15 mm and maximum width of 76 mm. If multiple cables are being supported, the narrowest width cable must not be less than 70% of the width of the widest cable.

Order two devices per cable, one for the car and one for the hoistway.

Note: Sizes are approximate and may deviate slightly.

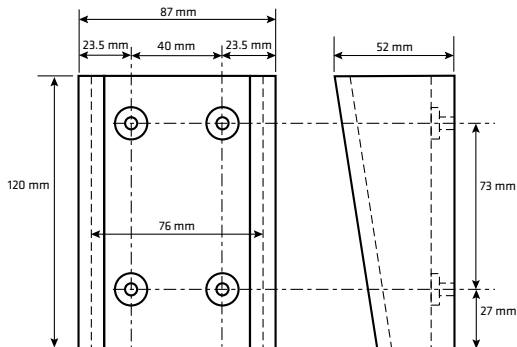

Flat Cable Suspension Devices

FOR UNSUPPORTED AND STEEL-SUPPORTED FLAT CABLES - STEEL CONSTRUCTION

Large cable version

Part Number	Description
FCSD-4P	Flat cable suspension device for one large cables, max 4 101 mm wide Mounting holes are 6,6 mm with 17 mm counterbore

The FCSD-4P is made of a durable nylon/plastic. It consists of a bracket that attaches to the hoistway wall or the car, and a clamping wedge that secures the cable in the bracket.

The FCSD-4P is designed to hold a single cable up to a maximum thickness of 12,7 mm and maximum width of 101 mm.

Order two devices per cable, one for the car and one for the hoistway.

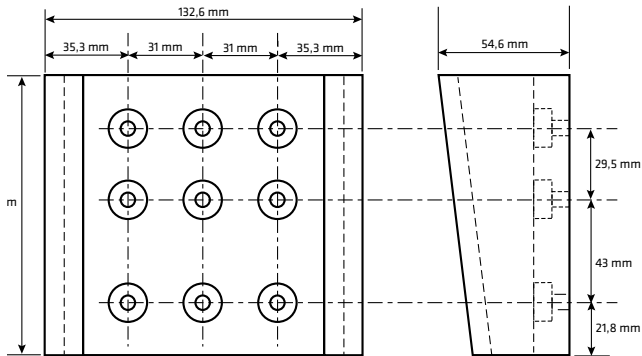

Steel supported version

Part Number	Description
FCSD-S	Flat cable suspension device for steel supported cables. Mounting holes are 7,14 mm

The FCSD-S is formed of sheet steel. It attaches to the hoistway wall or the car. The steel support cable is carried by the four 9,5 mm carbon-steel support studs, and held in place by the front bracket.

The FCSD-S is designed to hold up to three cables totaling a maximum thickness of 16 mm. Maximum supported weight is 681 kg.

Order two devices per cable, one for the car and one for the hoistway

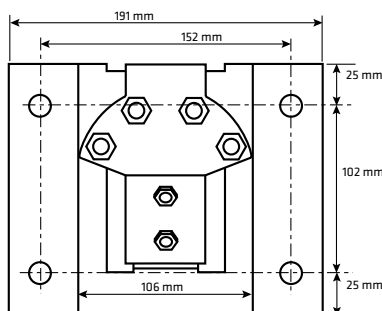

Flat Travelling Cable Installation

1) UNSUPPORTED CABLE CONFIGURATION

UPPER MACHINE ROOM INSTALLATION

Unsupported cable is attached with hanging devices at the shaft midpoint and at the bottom of the car. Another hanging device may be needed at the top of the shaft (see step 9).

The maximum hanging length for unsupported cable is 61 m • 200 ft (NEC) or 46 m • 150 ft (EN).

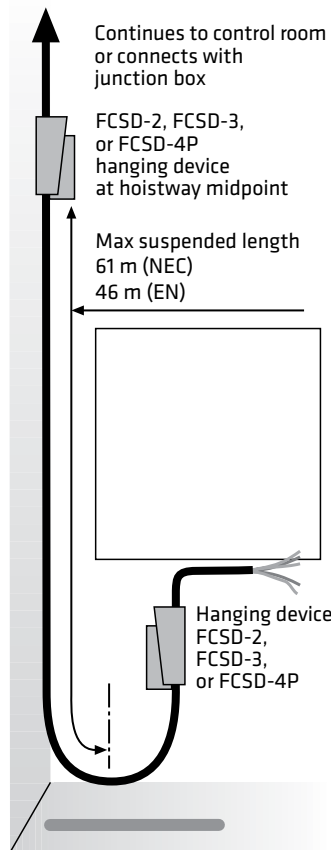

2) UNSUPPORTED CABLE CONFIGURATION

LOWER MACHINE ROOM INSTALLATION

In some cases, the controller is located at the first landing. A third hanging device is needed to direct the cable downward.

The maximum hanging length for unsupported cables is 45 m. Some cables may be less than 45 m. Please consult your specifications.

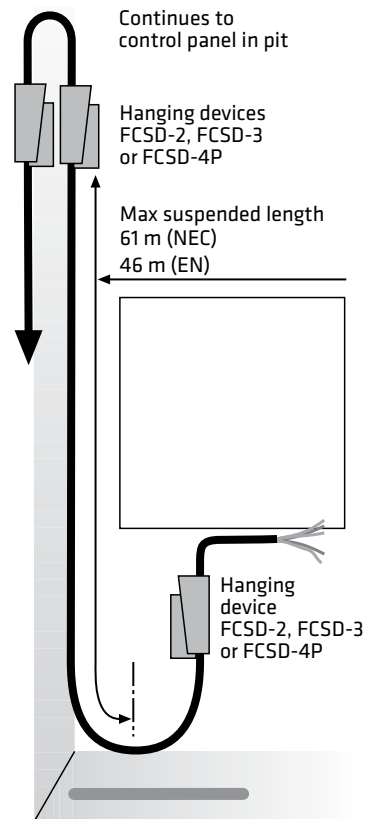

3) SUPPORTED CABLE CONFIGURATION

UPPER MACHINE ROOM INSTALLATION

Steel supported flat cable is attached with hanging devices at the hoistway top and at the bottom of the car.

The maximum hanging length for supported cable varies.

Check this catalog for the maximum hanging length for the cable you are installing.

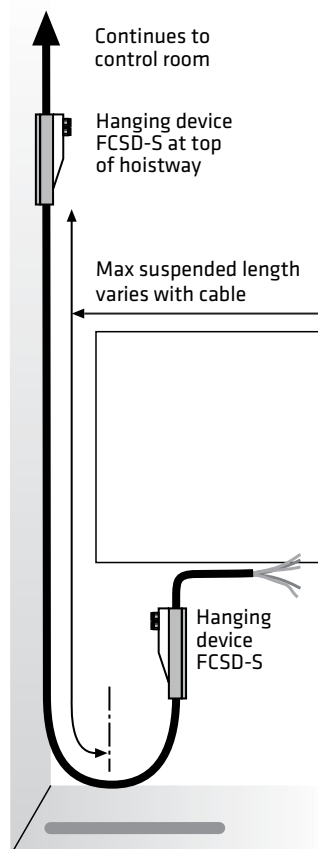

4) CABLE INSPECTION

Inspect the cable immediately upon arrival. Store the cable in a protected area away from possible damage.

A cut or gash in the jacket could mean an unsafe cable. Damaged reels or boxes are a sign of rough handling in transit and may indicate cable damage.

DO NOT INSTALL POTENTIALLY DAMAGED CABLE. Call Draka Elevator if you have any questions regarding damaged cable.



Flat Travelling Cable Installation

7) CABLE REEL STORAGE AND MOVEMENT

Flat cable may be moved by forklift. Lift the reel by the wood, not by the cable.

The reel may be rolled on a firm surface.

If a hoist is being used, place a strong rod through the reel and lift it by that.

Reels made of lumber must be stored upright and not stacked.

Reels made of plywood can be stored on their sides provided they are covered in stretch wrap material and not stacked more than two high.

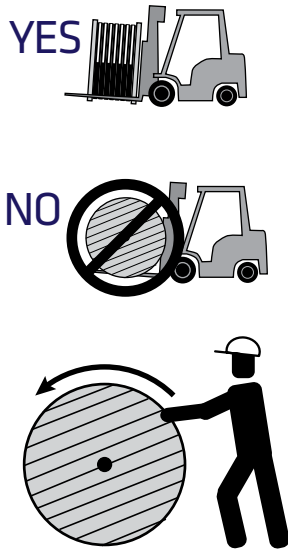

6) DETERMINE HANGER PLACEMENT

Flat cable connects the cab to the controller at either the top or bottom of the hoistway.

In both cases, the cable must travel in a straight plane.

Unsupported cables will be supported by hanging devices at the midpoint of the hoistway and at the car. An optional hanging device is sometimes used at the top of the hoistway.

Supported cables will be hung by their steel supports with a hanging device placed at the top of the hoistway or at the hoistway midpoint.

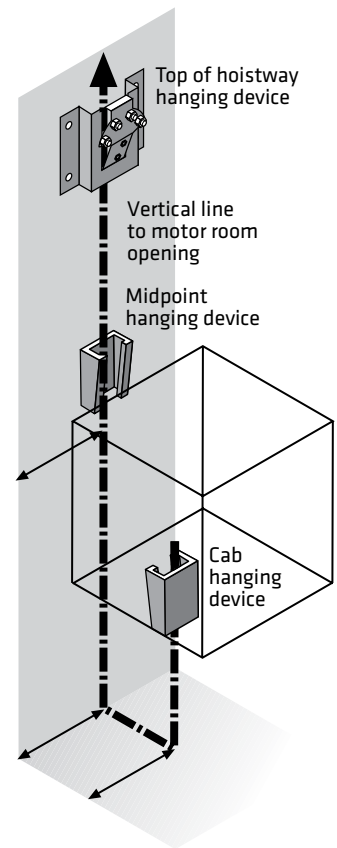

7) SELECT A HANGING DEVICE

For unsupported installations, the FCSD-2 will hold up to two cables, one up to 52 mm. wide, and a second no less than 70% of the width of the wider one. Maximum total thickness of the cables is 12 mm.

The FCSD-3 will hold up to three unsupported cables, one up to 75 mm wide, and the second/third no less than 70% of the width of the wider one. Maximum thickness of the installed cables is 15 mm.

The FCSD-4P will hold multiple unsupported cables up to a maximum width of 114 mm. Maximum thickness of the installed cables is 15 mm.

For supported installations, the FCSD-S holds up to three cables with a maximum thickness of 16 mm.

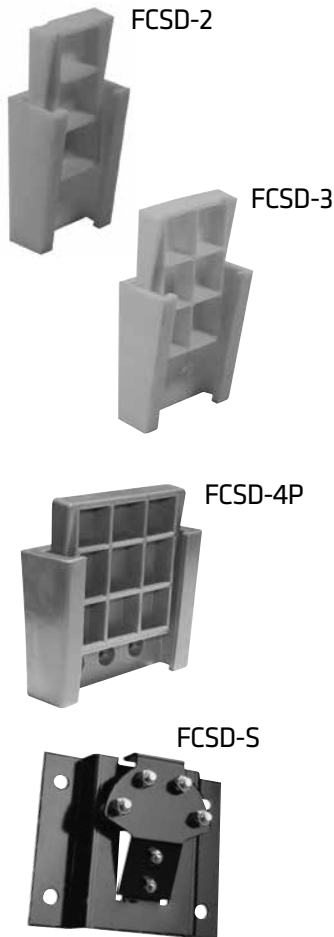

8) MOUNTING THE SHAFT HANGER FOR UNSUPPORTED CABLE

GO TO STEP 11 FOR SUPPORTED CABLES

The hanging device should be secured where it will not interfere with the moving car.

Locate the hanging position just above the midpoint of the hoistway (shown). Keep the position of the hanging device in line with the motor room opening.

Make sure that the edges of the hanging device are level, and that the narrow end of the wedge is oriented toward the bottom of the shaft.

Mark the drilling points with a pencil. Move the hanging device and drill the holes.

Bolt the hanging device into position using fasteners appropriate for the mounting surface (wall anchors, etc.).

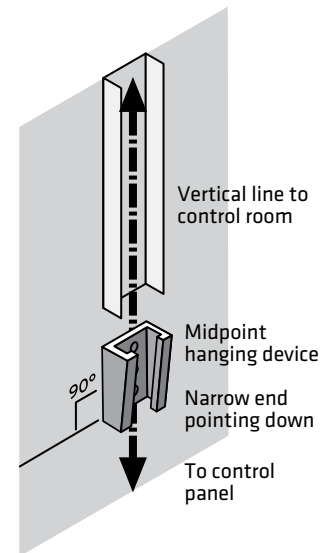

Flat Travelling Cable Installation

9) MOUNTING THE SHAFT HANGER FOR UNSUPPORTED CABLE

WITH THE CONTROLLER AT THE TOP OF THE SHAFT

For unsupported cable installations where the total run is longer than the maximum hanging length, a second hanging device for supporting the cable may be needed within a few feet of the top of the hoistway. It must be in line with the midpoint hanging device.

Supported cables will have one hanging device at the top of the shaft - no midpoint hanging device is needed.

It is helpful to have the raceway already in place to protect the stationary portion of cable.

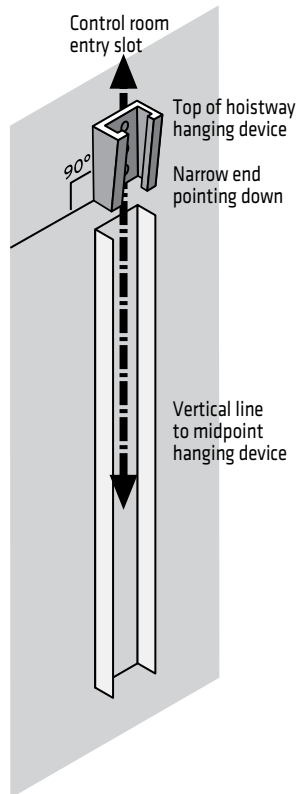

10) MOUNTING A SECOND SHAFT HANGER FOR UNSUPPORTED CABLE

WITH THE CONTROLLER AT THE BOTTOM OF THE SHAFT

For unsupported cable installations with a first floor machine room (such as a hydraulic), a second hanging device should be installed about 45 cm to the side of the midpoint hanging device.

Raceway can be installed for cable protection. The downward path should be vertical. Be sure the raceway is plumb.

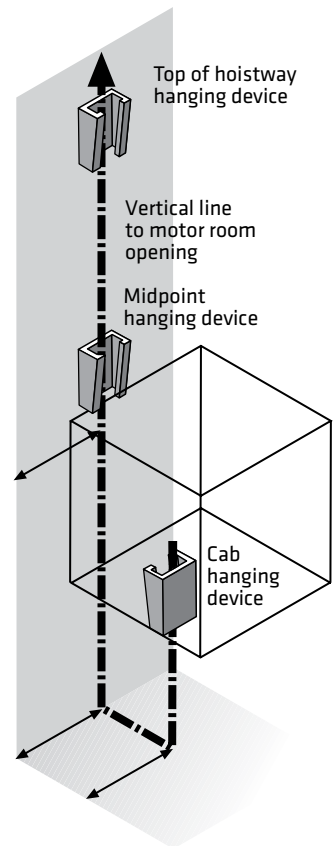

11) MOUNTING THE SHAFT HANGER FOR SUPPORTED CABLE

Do not install the FCSD-S until you are ready to expose the support members (see pages 18 and 19).

The hanging device should be secured where it will not interfere with the moving car.

For supported cables, the hanging position will be at the top of the hoistway or at the midpoint depending on the maximum cable hanging length.

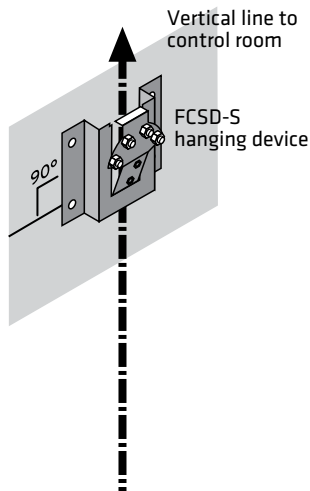

12) MOUNTING THE CAR HANGING DEVICE

DETERMINE PLACEMENT

It is critical that the hoistway hanging device(s) and the cab hanging device(s) are aligned on the same plane. Failure to do so will result in poor tracking.

Locate a place on the cab frame on the same plane as the hoistway hanging device. The horizontal distance between the hoistway hanging device and the car hanging device depends on the recommended cable loop.

When hanging parallel cables, set the devices between 51 mm and 102 mm apart.

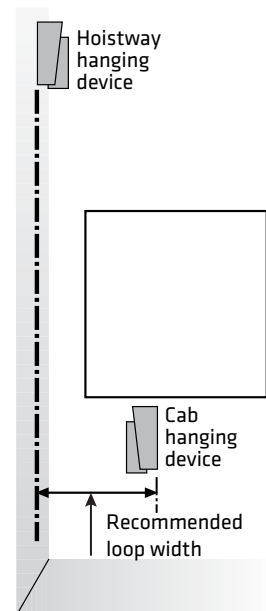

Flat Travelling Cable Installation

13) MOUNTING THE CAR HANGING DEVICE

ATTACH THE HANGING DEVICE

Locate a vertical surface under the car directly in line with the hoistway hanger to locate car cable hanger. Be sure to allow 10 cm minimum overhead clearance for the wedge and cable.

If no suitable location exists, mount the hanger to an appropriately-sized steel plate and secure the plate to the underside of the car.

A 90 degree angle bracket can be used to secure the hanger to a horizontal surface beneath the car.

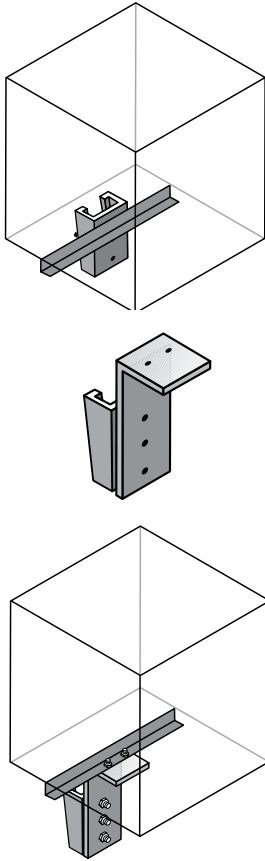

14) PLACING THE CABLE: PREFERRED METHOD

SECURE THE CABLE AND PLACE THE REEL

Prior to installing the cable, be sure that any hoistway obstructions are removed or, at the minimum, padded to avoid abrasion damage.

Place the reel(s) on reel rollers or jackstands in the car and proceed to the top floor. Feed enough cable into the machine room to connect with the controller and secure the end. If you are using a hanging device at the top of the hoistway, you may attach the cable there before lowering the cab.

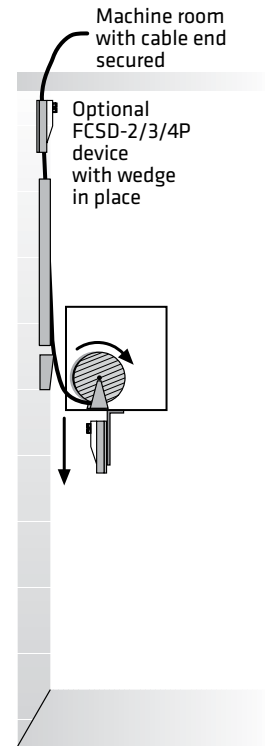

15) PLACING THE CABLE: PREFERRED METHOD

LOWER THE CAR AND PAY OUT THE CABLE

Slowly lower the car while carefully placing the cable into the raceway (if applicable) until the midpoint is reached.

The cable should pay off from the bottom of the reel so that the cable bend direction is consistent between the reel and the loop. If the flat cable is provided on coils, uncoil it as if it were on a reel, rotating it with your hands

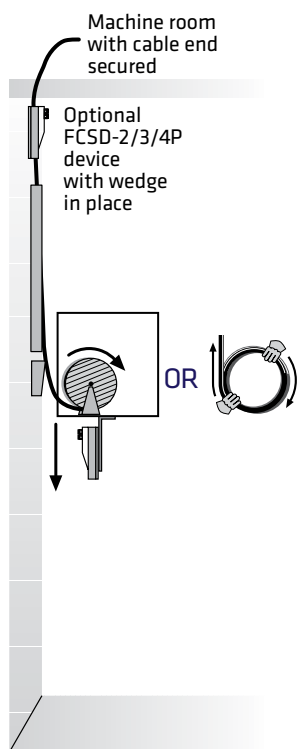

16) PLACING THE CABLE: ALTERNATE METHOD

DO NOT USE IF EXPECTING TO USE ALL OF THE CABLE ON THE REEL

Place the reel on reel rollers or jackstands in the machine room. Pay the cable off the top of the reel.

Make sure the reel can rotate freely.

Slowly lower the cable down the hoistway, until enough is available for undercar attachment, and then secure the cable in the hoistway hanger.

NOTE: Remember that the cable is NOT secured to the reel.

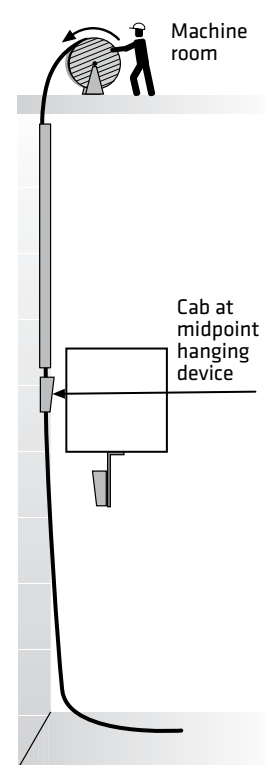

Flat Travelling Cable Installation

17) SECURE THE CABLE IN THE HANGING DEVICE

FOR UNSUPPORTED CABLES

Place the unsupported cable in the hanging device. If placing two cables, put the smaller one on top of the larger one.

Slide the clamping wedge in with the narrow end pointing down. Temporarily secure it with a few hammer taps. The cable should be firmly held but the wedge should be easily removed with a few hammer taps.

If you are running the cable to a first floor machine room, carefully fold the cable and place it as shown in the second hanging device.

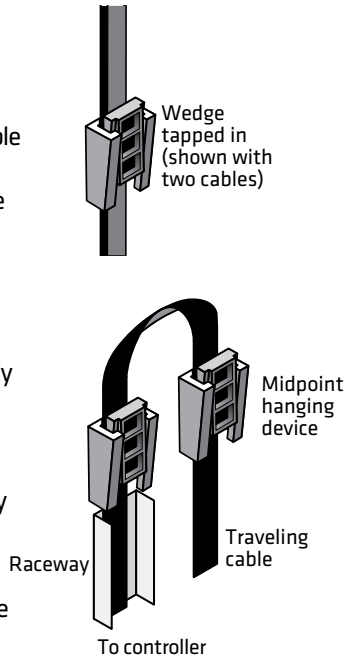

18) SECURE THE CABLE IN THE HANGING DEVICE

FOR SUPPORTED CABLES

With the supported cable being held in place in the machine room, locate the hanging position for the FCSD-S. Expose 610 mm of steel support members by slitting the edges of the cable with a utility knife. The midpoint of this slit should align with the FCSD-S.

Use cutters to snip the support members, being careful not to nick or cut any of the conductors. Pull the support members away from the cable. If you are running the cable to a first floor machine room, carefully fold the cable and place it as shown in the second hanging device.

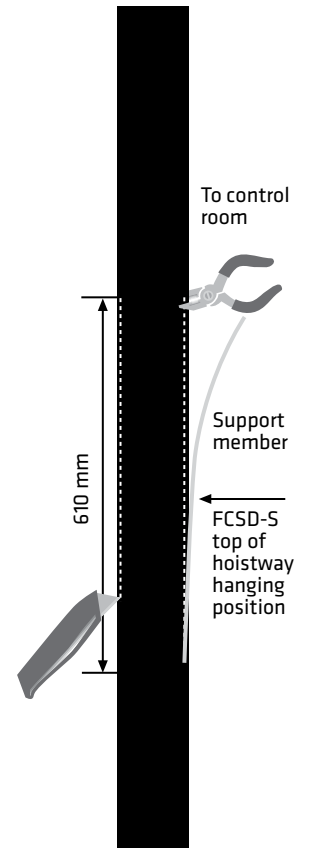

19) SECURE THE CABLE IN THE HANGING DEVICE

FOR SUPPORTED CABLES

Slide the cable under the FCSD-S leaving the steel support members free. Place one ferrule over each support member.

Loop the support members over the four nuts behind the semi-circular plate of the hanging device.

Run one support member through the opposing ferrule. Use a swaging tool to crimp each ferrule in three places.

Repeat with the other support member. When the cable is unsecured in the machine room, the support members will become taut and support the cable.

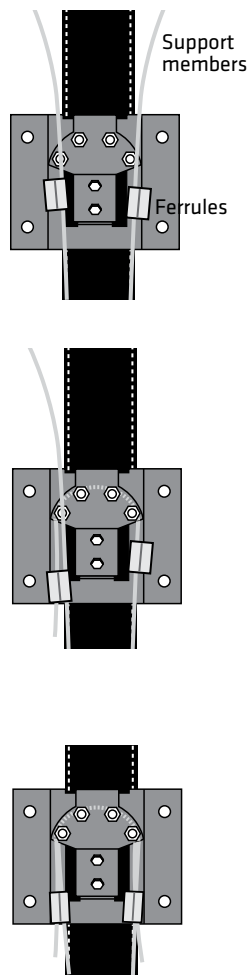

20) ATTACH THE CABLE TO THE CAR

Once the cable is temporarily secured at the midpoint, continue descending to the bottom of the hoistway.

Pay out enough cable to reach the hanging device on the bottom of the cab. There should be sufficient cable to set a proper loop with 15 cm or more clearance from the pit floor PLUS enough to reach its termination in the cab.

Cut the cable with tin snips or a wire cutter.

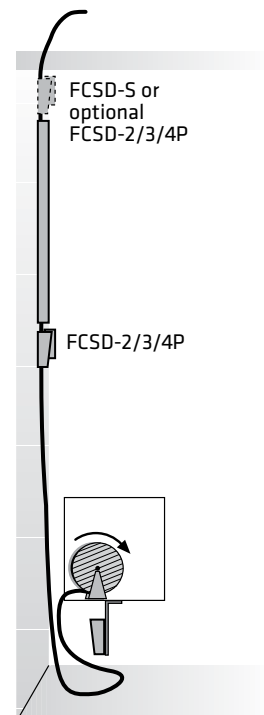

Flat Travelling Cable Installation

21) SETTING THE PROPER LOOP

Place the cable into the car hanger. Have a helper hold the cable in place while setting the loop.

The loop should not touch the cab's bottom edges and should not 'bell out.' The cable should hang vertically so that both legs of the loop are parallel.

If installing two or more cables, make sure there are 5 to 10 cm between the loops.

Once the loops are set, temporarily secure the cable in the hanging device by lightly tapping the wedge into place.

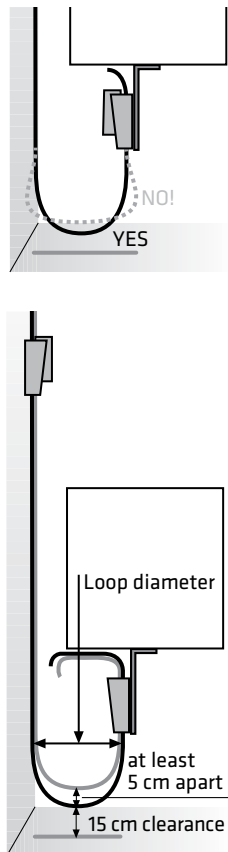

22) ADJUSTING THE TRACKING

If the cables are running off-plane, the cable tracking can be adjusted by VERY slightly angling the cable in the hanging devices. Angling the cable by as little as 3 mm off vertical will move a cable as much as 60 cm in a ten story building.

For unsupported cables, once proper tracking has been confirmed or established, firmly tap in the wedges at all hanging devices.

The cable should be tightly held but not crushed or deformed in the hanging devices. Do not let the wedge visibly compress the cable jacket.

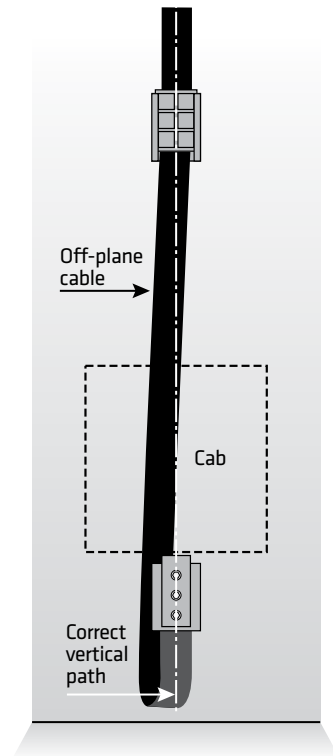

23) STRIPPING THE CABLE

The 36-135-M1 Flat Cable Stripper is the recommended tool for jacket removal.

Starting from the printed jacket surface, place the point of the guard between the conductor and jacket.

Pull the stripper smoothly for about 5 cm using a slight upward motion to avoid nicking the conductors.

Stripping will expose the ripcords in the cable. If more jacket needs to be removed, use needle-nose pliers to grip the ripcord, twisting it around the jaws of the pliers for more grip. Pull ripcords directly against the jacket to increase the strip length.

Electrical tape can be used to organize bundles of exposed conductors.



24) INSPECTION

A routine inspection program should be implemented to maximize product performance and safety.

Super-Flex® Travelling Cable Type ETT/300V

STEEL CENTER - UL LISTED, CSA CERTIFIED, NEC/CEC COMPLIANT - LIFETIME WARRANTY

Power, signal and shielded pairs



Part Number	Product Code	Number/Size of Conductors	Steel Core Dia. mm	Maximum Free Suspension Length* m	Cable Nominal Diameter mm	Cable Net Weight kg/km (approx.)
18-020-12	CWS 20	14 x 18 AWG 3 x 20 AWG shielded pairs	32,4	187	24,1	560
18-421-12	CWS 27	4 x 14 AWG 21 x 18 AWG 1 x 20 AWG shielded pair	4,0	275	24,4	744
18-431-12	CWS 37	4 x 14 AWG 31 x 18 AWG 1 x 20 AWG shielded pair	4,0	275	30,0	1,042
18-044-12	CWS 44	14 x 14 AWG 24 x 18 AWG 3 x 20 AWG shielded pairs	4,0	230	33,8	1,382
18-045-12	CWS 45 D	4 x 14 AWG 31 x 18 AWG 5 x 20 AWG shielded pairs	4,0	237	33,3	1,342
18-A46-12	CWS 46	8 x 14 AWG 30 x 18 AWG 4 x 20 AWG shielded pairs	4,0	234	33,5	1,354
18-441-12	CWS 47	4 x 14 AWG 41 x 18 AWG 1x 20 AWG shielded pair	4,0	275	30,5	1,147
18-47L-12	CWS 47 LO	11 x 14 AWG (conductors are numbered 1 to 11) 22 x 18 AWG (conductors are numbered 1 to 22) 7 x 20 AWG shielded pairs (red/white pairs in red, black, yellow orange, tan, blue and gray jackets)	4,0	212	35,6	1,498
18-648-12	CWS 56	6 x 14 AWG 48 x 18 AWG 1 x 20 AWG shielded pair	4,0	252	30,5	1,260
18-L58-12	CWS 58 LO	4 x 14 AWG (conductors are numbered 1 to 4) 40 x 18 AWG (conductors are numbered 1 to 40) 7 x 20 AWG shielded pairs (red/white pairs in red, black, yellow, orange, tan, blue and gray jackets)	4,0	190	38,4	1,674
18-H58-12	CWS 58 HI	4 x 14 AWG (conductors are numbered 5 to 8 [dark blue]) 40 x 18 AWG (conductors are numbered 41 to 80) 7 x 20 AWG shielded pairs (black/white pairs in red, black, yellow, orange, tan, blue and gray jackets)	4,0	1190	38,4	1,674

*For longer hang length applications, call with your requirements.

RG11/U coax and multimode optical fiber are available as options. See page X for specifics on these cables.

AWG to mm² conversion

14 AWG = 2,08 mm²

18 AWG = 0,82 mm²

20 AWG = 0,52 mm²

Super-Flex® Travelling Cable Type ETT/300V

STEEL CENTER - UL LISTED, CSA CERTIFIED, NEC/CEC COMPLIANT - LIFETIME WARRANTY

Power, signal and shielded pairs



Part Number	Product Code	Number/Size of Conductors	Steel Core Dia. mm	Maximum Free Suspension Length ¹ m	Cable Nominal Diameter mm	Cable Net Weight kg/km (approx.)
18-059-12	CWS 59	4 x 14 AWG 49 x 18 AWG 3 x 20 AWG shielded pairs	4,0	241	31,0	1,317
18-X60-12	CWS 60	7 x 14 AWG 27 x 18 AWG 13 x 20 AWG shielded pairs	6,4	275	40,1	1,918
18-869-12	CWS 69 SP	15 x 14 AWG 38 x 18 AWG 8 x 20 AWG shielded pairs	4,0	158	40,1	2,009
18-661-12	CWS 71	6 x 14 AWG 61 x 18 AWG 2 x 20 AWG shielded pairs	4,0	187	35,3	1,696
18-073-12	CWS 73	6 x 14 AWG 61 x 18 AWG 3 x 20 AWG shielded pairs	4,0	185	35,3	1,709
18-X74-12	CWS 74	20 x 14 AWG 38 x 18 AWG 8 x 20 AWG shielded pairs	4,0	150	39,1	2,122
18-469-12	CWS 75	4 x 14 AWG 69 x 18 AWG 1 x 20 AWG shielded pair	4,0	202	35,0	1,571
18-881-12	CWS 81	8 x 14 AWG 59 x 18 AWG 7 x 20 AWG shielded pairs	4,0	160	40,6	1,988
18-X90-12	CWS 90	6 x 14 AWG 80 x 18 AWG 2 x 20 AWG shielded pairs	4,0	169	137,1	1,878
18-X94-12	CWS 94	12 x 14 AWG 70 x 18 AWG 6 x 20 AWG shielded pairs	6,4	275	42,7	2,475
18-096-12	CWS 96	86 x 18 AWG 5 x 20 AWG shielded pairs	4,0	176	36,1	1,808



¹For longer hang length applications, call with your requirements.

RG11/U coax and multimode optical fiber are available as options. See page 4 for specifics on these cables.

AWG to mm² conversion

14 AWG = 2,08 mm²

18 AWG = 0,82 mm²

20 AWG = 0,52 mm²

Super-Flex® Travelling Cable Type ETT/300V

STEEL CENTER - UL LISTED, CSA CERTIFIED, NEC/CEC COMPLIANT - LIFETIME WARRANTY

Power and signal conductors



Part Number	Product Code	Number/Size of Conductors	Steel Core Dia. mm	Maximum Free Suspension Length ¹ m	Cable Nominal Diameter mm	Cable Net Weight kg/km (approx.)
18-004-11	WS 4-14	4 x 14 AWG	2,4	275	14,4	247
18-008-11	WS 8-14	8 x 14 AWG	3,2	275	17,8	436
18-015-11	WS 15-14	15 x 14 AWG	3,2	275	23,6	725
18-310-11	WS 10-18	10 x 18 AWG	2,4	275	14,2	260
18-412-11	WS 12-18	12 x 18 AWG	2,4	275	16,5	417
18-420-11	WS 20-18	20 x 18 AWG	2,4	245	18,0	426
18-430-11	WS 30-18	30 x 18 AWG	3,2	275	20,8	620
18-440-11	WS 40-18	40 x 18 AWG	3,2	275	23,4	757
18-450-11	WS 50-18	50 x 18 AWG	3,2	242	25,7	936

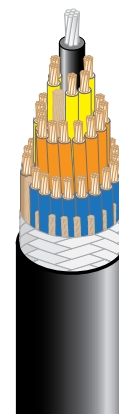

Shielded pairs only



Part Number	Product Code	Number/Size of Conductors	Steel Core Dia. mm	Maximum Free Suspension Length ¹ m	Cable Nominal Diameter mm	Cable Net Weight kg/km (approx.)
18-002-15	WSCC 4x20 SH	4 x 20 AWG shielded pairs	3,2	275	20,0	491
18-003-15	WSCC 6x20 SH	6 x 20 AWG shielded pairs	3,2	275	21,6	543
18-004-15	WSCC 8x20 SH	8 x 20 AWG shielded pairs	4,0	275	25,4	729
18-403-15	WSCC 6x18 SH	6 x 20 AWG shielded pairs	4,0	275	23,6	622
18-407-15	WSCC 14x18 SH	14 x 20 AWG shielded pairs	4,0	218	36,6	1460

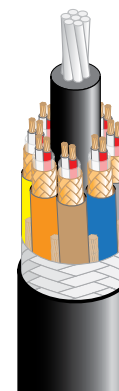

¹For longer hang length applications, call with your requirements.

RG11/U coax and multimode optical fiber are available as options. See page X for specifics on these cables.

AWG to mm² conversion

14 AWG = 2,08 mm²

18 AWG = 0,82 mm²

20 AWG = 0,52 mm²

YSLTK-JZ/300 - 500V

SMALL DIAMETER TRAVELLING CABLE FOR LOWER RISES / RAYON SUPPORT

Power and signal conductors

Part Number	Product Code	Number/Size of Conductors mm ²	Support Dia. mm	Maximum Free Suspension Length ¹ m	Cable Maximum Diameter mm	Cable Net Weight kg/km (approx.)
20131108		12x1,0	3,2	50	17,7	370
20003126		18x1,0	2,4	50	17,7	400

Other configurations available on request

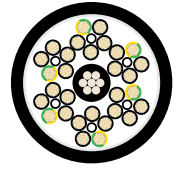

Round Cable Hanging Accessories

FOR JUTE AND STEEL CENTER TRAVELLING CABLE INSTALLATION

Universal Hanging System - US patent 5,080,199

Part Number	For Steel Core Dia. mm	Number/ of Cables Held	Max. per cable Load kg
3/32-1 SBKT	2,4	1 cable	227
1/8-1 SBKT	3,2	1 cable	227
5/32-1 SBKT-R	4,0	1 cable	318
1/4-1 SBKT	6,4	1 cable	568

The Universal Hanging System is based around our patented Steel-Core Hanging Device which is designed to solidly grip and support the steel wire support member. It also safely secures the cable to the welded steel bracket thus preventing rotation.

The Universal Hanging System is a safe and effective unit that saves time and labour. It also has the added benefit of not having to bend (and possibly compromise) the steel support as required in other termination methods.

The Universal Hanging System is available in one and two cable configurations and comes as a kit with all installation hardware. Order two kits per cable, one for the car and one for the hoistway.

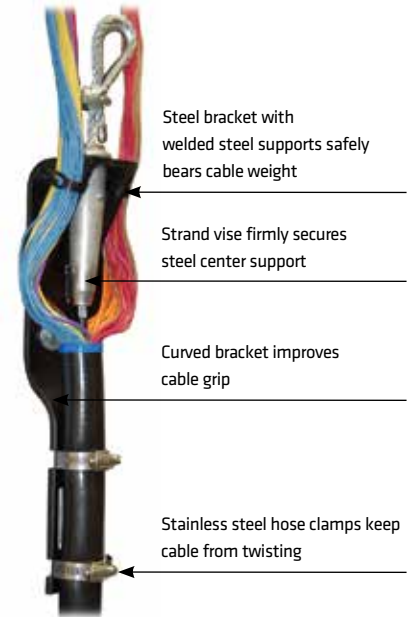

Universal hanging system for two cables

Part Number	For Steel Core Dia. mm	Number/ of Cables Held mm	Max. per cable Load lbs • kg
5/32-2 SBKT-R	4,0	2 cables	318
1/4-2 SBKT	6,4	2 cables	568

These are two-cable versions of the Universal Hanging System. They use the same replacement strand vises shown below.



Replacement strand vises

Part Number	Description
3/32 PINS-A	Replacement strand vise for 2,4 mm rope
1/8 PINS-A	Replacement strand vise for 3,2 mm rope
5/32 PINS-A	Replacement strand vise for 4,0 mm rope
1/4 PINS-A	Replacement strand vise for 6,4 mm rope

Replacement strand vises are for use ONLY in Universal Hanging Systems.

Jute core travelling cable hanger for mesh grips

Part Number	Description
HGRJC-8	Bracket used to hold/support grips that hold jute core cables - 20 cm clear between brackets

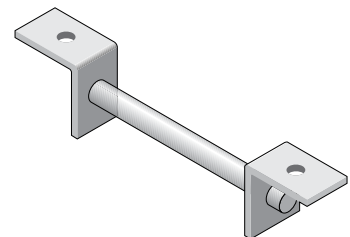

Beam pads

Part Number	Description
22-022	Scotch 2200 beam pads, 165 x 114 x 6 mm, packages of 10, may be purchased individually

Draka recommends beam pads be applied to surfaces where there may be occasional contact by the travelling cable.



Mesh Grips

TINNED BRONZE FOR JUTE CENTER TRAVELLING CABLES - MAXIMUM HANGING LENGTHS OF 61 M

Single eye / single weave / closed mesh - tinned bronze

Part Number	Cable Dia, Range cm	Maximum Load* kg	Eye Length mm	Nominal Mesh Length mm
022-01-013	1,27 to 1,57	48	178	254
022-01-014	1,60 to 1,88	72	203	254
022-01-015	1,91 to 2,51	93	203	330
022-01-017	2,54 to 3,15	146	229	356
022-01-018	3,18 to 3,78	146	254	381
022-01-019	3,81 to 4,42	146	305	432
022-01-020	4,45 to 5,05	195	356	483



Single eye / single weave / split laced - tinned bronze

Part Number	Cable Dia, Range cm	Maximum Load* kg	Eye Length mm	Nominal Mesh Length mm
022-02-013	1,27 to 1,57	72	178	254
022-02-014	1,60 to 1,88	72	203	254
022-02-015	1,91 to 2,51	93	203	330
022-02-017	2,54 to 3,15	146	229	355
022-02-018	3,18 to 3,78	146	1254	381
022-02-019	3,81 to 4,42	146	305	431
022-02-020	4,45 to 5,05	195	356	419



Single eye / single weave / split rod - tinned bronze

Part Number	Cable Dia, Range cm	Maximum Load* kg	Eye Length mm	Nominal Mesh Length mm
022-03-061	0,94 to 1,24	48	102	127
022-03-013	1,27 to 1,57	48	178	254
022-03-014	1,60 to 1,88	72	203	254
022-03-015	1,91 to 2,51	93	203	330
022-03-017	2,54 to 3,15	146	229	356
022-03-018	3,18 to 3,78	146	254	381
022-03-019	3,81 to 4,42	146	305	432
022-03-020	4,45 to 5,05	195	356	483



Universal bale / single weave / split rod - tinned bronze

Part Number	Cable Dia, Range cm	Maximum Load* kg	Eye Length mm	Nominal Mesh Length mm
022-03-066	1,91 to 2,51	93	400	267
022-03-068	2,54 to 3,15	146	400	317
022-03-069	3,18 to 3,78	146	400	368
022-03-070	3,81 to 4,42	146	400	394
022-03-071	4,45 to 5,05	195	400	419



*Maximum Load is based on minimum breaking strength with a 4:1 safety factor,

Mesh Grips

TINNED BRONZE FOR JUTE CENTER TRAVELLING CABLES - MAXIMUM HANGING LENGTHS OF 61 M

Double eye / single weave / split laced- tinned bronze

Part Number	Cable Dia, Range cm	Maximum Load* kg	Eye Length mm	Nominal Mesh Length mm
022-02-002	1,60 to 1,88	77	102	254
022-02-003	1,91 to 2,51	93	140	330
022-02-005	2,54 to 3,15	146	127	356
022-02-006	3,18 to 3,78	146	127	381
022-02-007	3,81 to 4,42	146	127	432



Double eye / single weave / split rod - tinned bronze

Part Number	Cable Dia, Range cm	Maximum Load* kg	Eye Length mm	Nominal Mesh Length mm
022-03-001	1,27 to 1,57	72	102	165
022-03-002	1,60 to 1,88	72	102	216
022-03-003	1,91 to 2,51	93	140	267
022-03-005	2,54 to 3,15	146	127	317
022-03-006	3,18 to 3,78	146	127	368
022-03-007	3,81 to 4,42	146	127	394
022-03-008	4,45 to 5,05	195	152	419



Double eye / single weave / closed mesh - tinned bronze

Part Number	Cable Dia, Range cm	Maximum Load* kg	Eye Length mm	Nominal Mesh Length mm
022-01-001	1,27 to 1,57	48	102	254
022-01-002	1,60 to 1,88	72	102	254
022-01-003	1,91 to 2,51	93	140	304
022-01-005	2,54 to 3,15	146	127	356
022-01-006	3,18 to 3,78	146	127	381
022-01-007	3,81 to 4,42	146	127	432
022-01-008	4,45 to 5,05	195	152	483



*Maximum Load is based on minimum breaking strength with a 4:1 safety factor,

Mesh Grips

STAINLESS STEEL FOR TRAVELLING CABLES - MAXIMUM HANGING LENGTHS OF 61 M

Double eye / double weave / split laced - stainless steel

Part Number	Cable Dia, Range cm	Maximum Load* kg	Eye Length mm	Nominal Mesh Length mm
024-20-1284	1,91 to 2,51	282	102	330
024-20-1285	2,54 to 3,15	364	102	356
024-20-1286	3,18 to 3,78	364	102	381
024-20-1287	3,81 to 4,42	364	102	432
024-20-1500	4,45 to 5,08	818	305	483



Double eye / single weave / split rod - stainless steel

Part Number	Cable Dia, Range cm	Maximum Load* kg	Eye Length mm	Nominal Mesh Length mm
024-03-005	2,54 to 3,15	241	127	317
024-03-006	3,18 to 3,78	409	127	368
024-03-007	3,81 to 4,42	409	127	394
024-03-008	4,45 to 5,08	545	152	419



Double eye / double weave / closed mesh - stainless steel

Part Number	Cable Dia, Range cm	Maximum Load* kg	Eye Length mm	Nominal Mesh Length mm
024-20-1504	2,54 to 3,15	545	305	1356
024-20-1470	3,18 to 3,78	745	305	381
024-20-1510	3,81 to 4,42	755	305	432
024-20-1499	4,45 to 5,05	818	305	483
024-20-1542	5,08 to 6,35	818	305	533



Single eye / single weave / split rod - stainless steel

Part Number	Cable Dia, Range cm	Maximum Load* kg	Eye Length mm	Nominal Mesh Length mm
024-03-014	1,60 to 1,88	186	203	216
024-03-015	1,91 to 2,51	186	203	267
024-03-017	2,54 to 3,15	240	229	317
024-03-018	3,18 to 3,78	408	254	368
024-03-019	3,81 to 4,42	408	305	394



Universal bale / single weave / split rod - stainless steel

Part Number	Cable Dia, Range cm	Maximum Load* kg	Eye Length mm	Nominal Mesh Length mm
024-03-066	1,91 to 2,51	153	400	267
024-03-068	2,54 to 3,15	241	400	317
024-03-069	3,18 to 3,78	241	400	368
024-03-070	3,81 to 4,42	241	400	394



*Maximum Load is based on minimum breaking strength with a 4:1 safety factor.

Power Cable Type H07RN-F

FLEXIBLE CABLE MANUFACTURED TO EN 50525-2-21

450 / 750 V - conductors coloured to HD 308 S2:2001

Number/Size of Conductors N x mm ²	Nominal Diameter mm	Net Weight (approx.) kg/km	Bend Radius mm	Conductor Resistance Ω/km	Short Circuit Current / 1 sec kA	Time Heating Constant sec	Ampacity (Air temp?) Amps	Inductivity mH/km	Copper Content kg/km
1 x 1,5	7	58	28	13,300	0,212	46	16	n/a	15
1 x 2,5	7	75	28	7,980	0,352	82	20	n/a	25
1 x 4	9	105	36	4,950	0,564	94	30	n/a	39
1 x 6	10	138	40	3,300	0,846	131	38	n/a	59
1 x 10	12	204	48	1,910	1,410	187	53	n/a	98
1 x 16	13	286	65	1,210	2,260	267	71	n/a	157
1 x 25	13	390	75	0,780	3,530	372	94	n/a	245
1 x 35	15	523	85	0,554	4,930	471	117	n/a	343
1 x 50	17	699	95	0,386	7,050	600	148	n/a	490
1 x 70	20	950	132	0,272	9,870	753	185	n/a	686
1 x 95	22	1.202	144	0,206	13,400	963	222	n/a	931
1 x 120	24	1.524	162	0,161	16,900	1.120	260	n/a	1.176
1 x 150	26	1.839	174	0,129	20,891	1.315	300	n/a	1.470
1 x 185	29	2.184	186	0,106	26,500	1.548	341	n/a	1.813
1 x 240	33	2.840	210	0,080	34,300	1.829	407	n/a	2.352
1 x 300	35	3.413	228	0,064	42,900	2.161	468	n/a	2.940
2 x 1	10	112	40	19,500	1,410	53	10	0,349	20
2 x 1,5	10	136	40	13,300	0,212	46	16	0,334	29
2 x 2,5	12	190	48	7,980	0,352	53	25	0,322	49
2 x 4	14	271	70	4,950	0,564	73	34	0,303	78
2 x 6	16	372	80	3,300	0,846	102	43	0,277	118
2 x 10	22	643	132	1,910	1,410	146	60	0,271	196
2 x 16	24	859	144	1,210	2,260	216	79	0,260	314
2 x 25	28	1.197	168	0,780	3,530	298	105	0,256	490
3 x 1	10	134	40	19,500	0,141	53	10	0,349	29
3 x 1,5	11	162	44	13,300	0,212	46	16	0,334	44
3 x 2,5	13	229	65	7,980	0,352	82	20	0,322	74
3 x 4	15	329	75	4,950	0,564	100	29	0,303	118
3 x 6	18	452	90	3,300	0,846	146	36	0,277	176
3 x 10	23	776	138	1,910	1,410	202	51	0,271	294
3 x 16	26	1.058	156	1,210	2,260	300	67	0,260	470
3 x 25	30	1.473	180	0,780	3,530	415	89	0,256	735
3 x 35	34	1.728	204	0,554	4,930	533	110	0,247	1.029
3 x 50	39	2.302	234	0,386	7,050	690	138	0,245	1.470
3 x 70	46	3.094	276	0,272	9,870	871	172	0,234	2.058
3 x 95	50	3.920	300	0,206	13,400	1141	204	0,236	2.793
3 x 120	56	4.936	336	0,161	16,900	1.337	238	0,229	3.528



Data are for informational purposes and are subject to improvement without notice.

Features

H07RN-F cables are designed to carry power from mains to elevator equipment. They are tough yet flexible and can withstand harsh environments (mechanical stress, high and low temperature, dampness, etc.). They are oil-resistant and can be used outdoors.

Test voltage:	2,5 kV
Max. short-circuit temperature:	+200 °C
Conductor operating temperature:	-30 to +60 °C
Min. installation/handling temperature:	-25 °C
Min. storage temperature:	-35 °C

Construction

Fine stranded copper conductor, class 5

Separating foil

Rubber (EPR) insulation

Textile tape

Inner rubber sheath

Outer polychloroprene (PCP) sheath

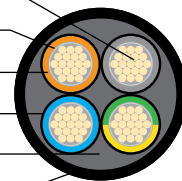

Power Cable Type H07RN-F

FLEXIBLE CABLE MANUFACTURED TO EN 50525-2-21

450 / 750 V - conductors coloured to HD 308 S2:2001

Number/Size of Conductors mm ²	Nominal Diameter mm	Net Weight (approx.) kg/km	Bend Radius mm	Conductor Resistance Ω/km	Short Circuit Current / 1 sec kA	Time Heating Constant sec	Ampacity (Air temp?) Amps	Inductivity mH/km	Copper Content kg/km
4x1	11	163	44	19,500	0,141	53	10	0,372	39
4x1,5	12	197	48	13,300	0,212	46	16	0,357	59
4x2,5	14	279	70	7,980	0,352	82	20	0,345	98
4x4	16	402	80	4,950	0,564	94	30	0,326	157
4x6	20	561	100	3,300	0,846	138	37	0,300	235
4x10	25	935	150	1,910	1,410	195	52	0,294	392
4x16	28	1286	168	1,210	2,260	283	69	0,283	627
4x25	31	1692	204	0,780	3,530	388	92	0,279	980
4x35	34	2266	228	0,554	4,930	496	114	0,270	1372
4x50	40	3021	258	0,386	7,050	643	143	0,268	1960
4x70	46	4087	300	0,272	9,870	813	178	0,257	2744
4x95	52	5227	330	0,206	13,400	1076	210	0,259	3724
4x120	56	6521	372	0,161	16,900	1252	246	0,252	4704
5x1	12	195	48	19,500	0,141	53	10	0,256	49
5x1,5	13	234	65	13,300	0,212	46	16	0,259	74
5x2,5	15	348	75	7,980	0,352	82	20	0,269	123
5x4	18	504	90	4,950	0,564	94	30	0,293	196
5x6	22	704	132	3,300	0,846	131	38	0,335	294
5x10	29	1155	174	1,910	1,410	180	54	0,433	490
5x16	31	1482	186	1,210	2,260	267	71	0,561	784
5x25	34	2123	222	0,780	3,530	372	94	0,712	1225
7x1,5	16	329	80	13,300	0,212	46	16	0,316	89
7x2,5	18	461	90	7,980	0,352	82	20	0,292	147
7x4	21	671	126	4,950	0,564	94	30	0,274	235
12x1,5	19	548	126	13,300	0,212	46	16	n/a	176
12x2,5	22	758	144	7,980	0,352	82	20	n/a	294
12x4	29	1124	174	4,950	0,564	135	25	n/a	470
18x1,5	24	777	144	13,300	0,212	46	16	n/a	265
18x2,5	28	1103	168	7,980	0,352	82	20	n/a	441
18x4	34	1637	204	4,950	0,564	135	25	n/a	706
24x1,5	28	999	168	13,300	0,212	46	16	n/a	353
24x2,5	33	1430	198	7,980	0,352	82	20	n/a	588
36x1,5	32	1378	192	13,300	0,212	46	16	n/a	530
36x2,5	37	2029	222	7,980	0,352	82	20	n/a	882



Data are for informational purposes and are subject to improvement without notice.

Cable constructions that are not listed, e.g. four conductor cables with a smaller ground, are produced as A07RN-F.

Features

H07RN-F cables are designed to carry power from mains to elevator equipment. They are tough yet flexible and can withstand harsh environments (mechanical stress, high and low temperature, dampness, etc.). They are oil-resistant and can be used outdoors.

Test voltage:	2,5 kV
Max. short-circuit temperature:	+200 °C
Conductor operating temperature:	-30 to +60 °C
Min. installation/handling temperature:	-25 °C
Min. storage temperature:	-35 °C

Construction

Fine stranded copper conductor, class 5

Separating foil

Rubber (EPR) insulation

Textile tape

Inner rubber sheath

Outer polychloroprene (PCP) sheath

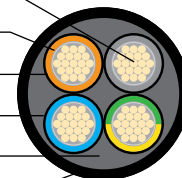

Power Cable Type H05RN-F

FLEXIBLE CABLE MANUFACTURED TO EN 50525-2-21

300 / 500 V - conductors coloured to HD 308 S2:2001

Number/Size of Conductors mm ²	Nominal Diameter mm	Net Weight (approx.) kg/km	Bend Radius mm	Conductor Resistance Ω/km	Short Circuit Current / 1 sec kA	Time Heating Constant sec	Ampacity (Air temp?) Amps	Inductivity mH/km	Copper Content kg/km
2x0,75	7	70	28	26,0	0,104	82	6	0,327	15
2x1	8	81	32	19,5	0,141	53	10	0,319	20
3x0,75	8	85	32	26,0	0,104	82	6	0,327	23
3x1	9	95	36	19,5	0,141	53	10	0,319	29

Data are for informational purposes and are subject to improvement without notice.



Features

H05RN-F cables are designed to carry power from mains to elevator equipment. They are tough yet flexible and can withstand harsh environments (mechanical stress, high and low temperature, dampness, etc.). They are oil-resistant and can be used outdoors.

Test voltage:	2,0 kV
Max. short-circuit temperature:	+200 °C
Conductor operating temperature:	-30 to +60 °C
Min. installation/handling temperature:	-25 °C
Storage temperature:	-35 °C

Construction

- Fine stranded copper conductor, class 5
- Rubber (EPR) insulation
- Outer polychloroprene (PCP) sheath

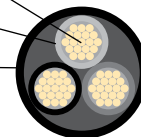

Power Cable Type H05RR-F

FLEXIBLE CABLE MANUFACTURED TO EN 50525-2-21

300 / 500 V - halogen-free to EN-50267-2-2 - conductors coloured to HD 308 S2:2001

Part Number	Number/Size of Conductors mm ²	Nominal Diameter mm	Net Weight (approx.) kg/km	Min. Bend Radius mm	Conductor Resistance 20° DC Ω/km	Conductor Resistance 90° 50 Hz Ω/km	Max. Current Rating* Amps	Mutual Inductance** mH/km	Max. Tensile Strength N
120672	2x0,75	6,0	55	25	26,7	30,9	6	0,33	22
120673	2x1	6,6	65	30	20,0	23,1	10	0,33	30
120674	2x1,5	8,0	95	35	13,3	15,4	16	0,32	45
120675	2x2,5	9,5	140	40	8,0	9,2	25	0,32	75
120669	3G0,75	6,6	70	30	26,7	30,9	6	0,33	33
120676	3G1,0	7,0	80	30	20,0	23,1	10	0,33	45
120679	3G1,5	8,5	115	35	13,3	15,4	16	0,32	67
120682	3G2,5	10,1	170	45	8,0	9,2	25	0,32	110
120677	4G1,0	7,6	95	35	20,0	23,1	9	0,42	60
120680	4G1,5	9,5	145	40	13,3	15,4	14	0,40	90
120683	4G2,5	11,3	215	50	8,0	9,2	22	0,39	150
120681	5G1,5	10,4	175	45	13,3	15,4	14	0,40	110
120684	5G2,5	12,6	260	65	8,0	9,2	22	0,39	185



Data are for informational purposes and are subject to improvement without notice.

*The maximum current rating applies to one cable in free air, at an ambient temperature of 30 °C based on HD 516 and NEN 1010:2007, table E.52-1.

Correction factors for other ambient temperatures than 30 °C are given in table E.52-6.

For 4- and 5-cores cables, the maximum current is given for 3 loaded cores.

**For 4- and 5-cores, the working self-inductance for 2 non-adjacent cores is given.

Features

H05RR-F cables are designed to carry power from mains to devices such as lamps or inspection controls. They are very flexible and can withstand harsh environments (mechanical stress, high and low temperature, dampness, etc.). They are oil-resistant and can be used outdoors.

Test voltage:	2,5 kV
Max. conductor temperature:	-30 to +60 °C
Operating temperature (flexible):	-25 to 50 °C
Storage temperature:	-25 to 60 °C

Construction

Fine stranded copper conductor, class 5

Rubber (EPR) insulation

Rubber (EPR) sheath

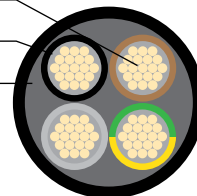

Core colours

2 cores: brown, blue

3 cores: brown, blue, green-and-yellow

4 cores: brown, black, gray, green-and-yellow

5 cores: brown, black, gray, blue, green-and-yellow

Power Cable Type H05VV-F

FLEXIBLE INDOOR CABLE MANUFACTURED TO EN 50525-2-11

300 / 500 V - Flame retardant to EN 60332-1

Number/Size of Conductors mm ²	Nominal Insulation Thickness mm	Nominal Sheath Thickness mm	Min. Insulation Resistance mΩ/km	Max. Current Capacity Amps	Nominal Cable Diameter mm	Net Weight (approx.) kg/km
2x0,75	0,6	0,8	0,010	6	6,1	59
3x0,75	0,6	0,8	0,011	6	6,5	71
4x0,75	0,6	0,8	0,011	5	7,1	82
5x0,75	0,6	0,9	0,011	5	7,9	108
2x1,0	0,6	0,8	0,010	10	6,5	69
3x1,0	0,6	0,8	0,010	10	6,9	84
4x1,0	0,6	0,9	0,010	9	7,7	108
5x1,0	0,6	0,9	0,010	9	8,4	123
2x1,5	0,7	0,8	0,010	16	7,4	94
3x1,5	0,7	0,9	0,010	16	8,1	118
4x1,5	0,7	1,0	0,010	14	9,0	149
5x1,5	0,7	1,1	0,010	14	10,0	177
2x2,5	0,8	1,0	0,009	25	9,0	145
3x2,5	0,8	1,1	0,009	25	9,8	182
4x2,5	0,8	1,1	0,007	22	9,0	226
5x2,5	0,8	1,2	0,009	22	11,9	262
2x4,0	0,8	1,1	0,007	33	10,3	201
3x4,0	0,8	1,2	0,007	33	11,1	248
4x4,0	0,8	1,2	0,007	28	12,2	323
5x4,0	0,8	1,4	0,007	28	13,5	358

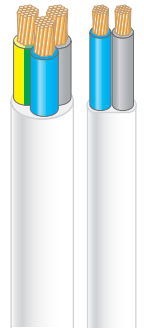

Data are for informational purposes and are subject to improvement without notice.

Features

H05VV-F cables are designed for light to medium duty in indoor and dry environments.

Test voltage:	2,0 kV
Operating temperature:	-25 to 70 °C
Maximum storage temperature:	40 °C
Minimum handling temperature:	-5 °C

Construction

Fine stranded copper conductor, class 5

Polyvinylchloride (PVC) insulation

Polyvinylchloride (PVC) sheath

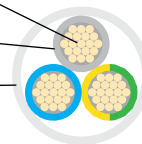

Core colours

Per HD 308 S2:2001

Power Cable Types H05V-U and H07V-U

SINGLE CORE WIRE FOR INDOOR WIRING TO EN 50525-2-31

H05V-U - 300 / 500 V - Flame retardant to EN 60332-1

Conductor Size mm ²	Nominal Diameter mm	Net Weight (approx.) kg/km	Conductor Resistance Ω/km	Current Rating Amps
0,50	2,1	9	36.000	10
0,75	2,2	11	24.500	13
1,0	2,4	14	18.100	17

H07V-U - 450 / 750 V - Flame retardant to ČSN EN 60332-1

Conductor Size mm ²	Nominal Diameter mm	Net Weight (approx.) kg/km	Conductor Resistance Ω/km	Current Rating Amps
1,5	2,8	20	12.100	23
2,5	3,4	31	7.410	31
4,0	3,9	46	4.610	41
6,0	4,4	64	3.080	54
10	5,6	108	1.830	74

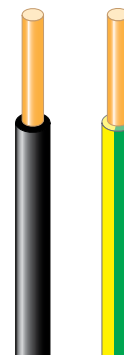

Data are for informational purposes and are subject to improvement without notice.

Features

H05V-U and H07V-U wires are used for fixed installations in conduit or under plaster for basic electrical wiring.

Test voltage for H05V-U: 2,0 kV

Test voltage for H07V-U: 2,5 kV

Operating temperature fixed: -40 to 70 °C

Storage temperature fixed: -40 to 40 °C

Minimum handling temperature for all: -5 °C

Construction

Solid copper conductor, H05V-U and H07V-U class 1, H07V-R class 2, H05V-K and H07V-K class 5

Polyvinylchloride (PVC) insulation



Core colours

Black, white, gray, brown, blue,

green/yellow, red; other colors on request

Power Cable Types H05V-K, H07V-K and H07V-R

SINGLE CORE WIRE FOR INDOOR WIRING TO EN 50525-2-31

H05V-K - 300 / 500 V - Flame retardant according to EN 60332-1

Conductor Size mm ²	Nominal Diameter mm	Net Weight (approx.) kg/km	Conductor Resistance Ω/km	Current Rating Amps
0,35	2,0	7	52.000	5
0,50	2,2	9	39.000	8
0,75	2,4	12	26.000	11
1,0	2,5	14	19.500	14

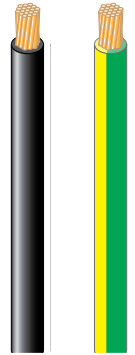

H07V-K - 450 / 750 V - Flame retardant according to ČSN EN 60332-1

Conductor Size mm ²	Nominal Diameter mm	Net Weight (approx.) kg/km	Conductor Resistance Ω/km	Current Rating Amps
1,5	3,0	20	13.300	21
2,5	3,6	32	7.980	28
4,0	4,1	46	4.950	38
6,0	4,7	64	3.300	49
10	6,0	109	1.910	72
16	7,2	164	1.210	100
25	8,9	254	0.780	140
35	10,7	357	0.554	175
50	13,1	517	0.386	218
70	15,0	715	0.272	266
95	17,3	932	0.206	330
120	19,3	1.185	0.161	384
150	21,5	1.482	0.129	420
185	23,6	1.778	0.106	462
240	26,8	2.350	0.0801	548

H07V-R - 450 / 750 V - Flame retardant according to ČSN EN 60332-1

Conductor Size mm ²	Nominal Diameter mm	Net Weight (approx.) kg/km	Conductor Resistance Ω/km	Current Rating Amps
1,5	3,0	22	12.100	21
2,5	3,6	34	7.410	28
4,0	4,1	47	4.610	38
6,0	4,7	64	3.080	49
10	6,0	109	1.830	72
16	7,2	165	1.150	100

Data are for informational purposes and are subject to improvement without notice.

Features

H05V-K, H07V-K AND H07V-R wires are used for fixed installations in conduit or under plaster for basic electrical wiring.

Test voltage for H05V-K: 2,0 kV

Test voltage for H07V-K and H07V-R: 2,5 kV

Operating temperature fixed: -40 to 70 °C

Storage temperature fixed: -40 to 40 °C

Minimum handling temperature for all: -5 °C

Construction

Stranded copper conductor, class 2 for H07V-R, class 5 for H05V-K and H07V-K

Polyvinylchloride (PVC) insulation



Core colours

Black, white, gray, brown, blue, green/yellow, red; other colors on request

Power Cable Types H05Z-K, H07Z-K and H07Z-R

SINGLE CORE WIRE FOR INDOOR WIRING TO EN 50525-3-41

H05Z-K - 300 / 500 V - Low smoke and halogen-free (90 °C)

Conductor Size mm ²	Nominal Diameter mm	Net Weight (approx.) kg/km	Conductor Resistance Ω/km	Current Rating Amps
0,50	2,2	10	39.000	13
0,75	2,4	12	26.000	17
1,0	2,5	16	19.500	21

H07Z-K - 450 / 750 V - Low smoke and halogen-free (90 °C)

Conductor Size mm ²	Nominal Diameter mm	Net Weight (approx.) kg/km	Conductor Resistance Ω/km	Current Rating Amps
1,5	3,0	22	13.300	27
2,5	3,6	35	7.980	36
4,0	4,1	47	4.950	47
6,0	4,7	70	3.300	63
10	6,0	108	1.910	85
16	7,2	160	1.210	112
25	8,9	265	0.780	155
35	10,7	357	0.554	190
50	13,1	499	0.386	235
70	15,0	694	0.272	297
95	17,3	922	0.206	355
120	19,3	1.168	0.161	415
150	21,5	1.380	0.129	470
185	23,6	1.700	0.106	505
240	26,8	2.200	0.0801	595

H07Z-R - 450 / 750 V - Low smoke and halogen-free (90 °C)

Conductor Size mm ²	Nominal Diameter mm	Net Weight (approx.) kg/km	Conductor Resistance Ω/km	Current Rating Amps
1,5	3,0	35	12.100	25
2,5	3,6	41	7.410	34
4,0	4,1	47	4.610	47
6,0	4,7	62	3.080	63
10	6,0	108	1.830	85
16	7,2	165	1.150	112

Data are for informational purposes and are subject to improvement without notice.

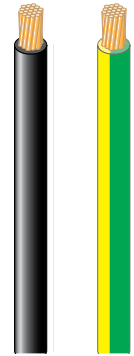

Features

H05Z-K, H07Z-K and H07Z-R wires are used for fixed installations in conduit or under plaster for basic electrical wiring.

Test voltage for H05Z-K: 2,0 kV

Test voltage for H07Z-K and H07Z-R: 2,5 kV

Operating temperature fixed: -40 to 90 °C

Storage temperature fixed: -40 to 40 °C

Minimum handling temperature for all: -5 °C

Construction

Stranded copper conductor, class 2 for H07Z-R, class 5 for H05Z-K and H07Z-K

Low smoke halogen-free insulation



Core colours

Black, white, gray, brown, blue,

green/yellow, red; other colors on request

Wire ducts

EN-50085-2-1, SELF-EXTINGUISHING PVC CLASS ONE (UL 94-VO), MEETS ALL EUROPEAN STANDARDS

Type G - solid sides



Part Number	Type	Dimension A mm	Dimension B mm	Metres per Carton	Package m ³	Carton Weight Kg	Cross-section mm ²
031674	AS / G8	40	40	40	0,057	16,0	1310
031643	AS / G4	60	40	24	0,051	13,0	1960
031698	AS / G9	60	60	24	0,069	18,0	3080
031735	AS / G26	80	40	24	0,069	15,8	2665
031667	AS / G6	80	60	24	0,092	22,0	4175
031612	AS / G17	100	60	20	0,092	21,0	5295
031629	AS / G19	100	80	16	0,092	21,2	7215
031605	AS / G10	120	60	16	0,085	19,3	6390
031636	AS / G32	120	80	16	0,106	23,1	8710
031711	AS / G33	150	80	12	0,106	21,2	10770

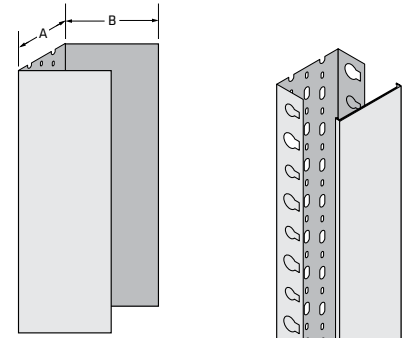

Wire duct comes in 2 metre lengths. Covers are included.

Note: 031605, 031636 and 031711 can be subdivided into three internal channels.

Type G/P - with knockout holes for conduit and tubing



Part Number	Type	Dimension A mm	Dimension B mm	Metres per Carton	Package m ³	Carton Weight Kg	Cross-section mm ²
031681	AS / G8P	40	40	40	0,057	16,0	1310
031650	AS / G4P	60	40	24	0,051	12,9	1960
031728	AS / G26P	80	40	24	0,069	15,4	2665

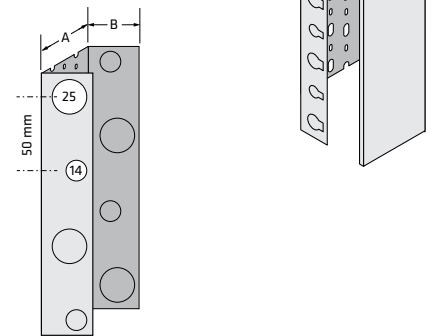

Wire duct comes in 2 metre lengths. Covers are included.

Type G/P - with pre-punched and slotted knockout holes



Part Number	Type	Dimension A mm	Dimension B mm	Metres per Carton	Package m ³	Carton Weight Kg	Cross-section mm ²
031568	G055P	50	50	24	0,051	12,72	126
031575	G075P	75	50	24	0,069	16,3	3115
031551	G105P	100	50	16	0,064	14,6	4270

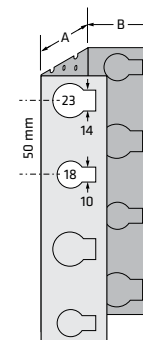

Wire duct comes in 2 metre lengths. Covers are included.

Note: 031551 can be subdivided into two internal channels.

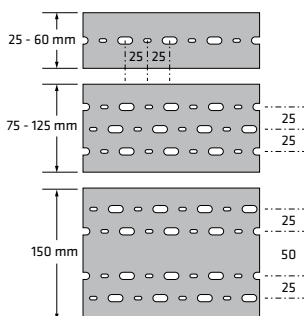

Connectors by WAGO®

Part Number	Description
721-1xx/008-000	Female connector, 2 to 24-pole, with snap-in mounting foot, for wire sizes 0,08 to 2,5 mm, pin spacing 5,0 mm, 100% protected against mismatching
721-1xx/026-000	Female connector, 2 to 24-pole, with two latches, for wire sizes 0,08 to 2,5 mm, pin spacing 5,0 mm, 100% protected against mismatching
734-1xx	Female connector, 2 to 24-pole, for wire sizes 0,08 to 2,5 mm, pin spacing 3,5 mm, 100% protected against mismatching, Cage Clamp connection
734-3xx LOW	Male connector, 2 to 24-pole, for wire sizes 0,08 to 2,5 mm, pin spacing 3,5 mm, 100% protected against mismatching, Cage Clamp connection



Replace the XX in the part number with the number of poles - i.e. 231-1XX becomes 231-106 for six poles.

Connector types and sizes from both WAGO and Weidmuller are available. Please call with your requirements.

Hoist ropes - 6 x 19 Seale

Part Number	Diameter mm	Core	Surface	Tensile Strength N/mm ²	Min. Breaking Load kN	Net Weight kg/m	Metallic section mm ²
7H060Z602A	6	Polypropylene	Galvanized	1960	23,2	0,129	14,2
7H063Z602A	6,3	Polypropylene	Galvanized	1960	21,0	0,142	15,9
7I080U602A	8	Sisal	Ungalvanized	1370/1770	33,2	0,230	25,2
7I090U602A	9	Sisal	Ungalvanized	1370/1770	42,0	0,291	32,0
7I100U602A	10	Sisal	Ungalvanized	1370/1770	51,8	0,359	39,4
7I110U602A	11	Sisal	Ungalvanized	1370/1770	62,7	0,434	47,7
7I120U602A	12	Sisal	Ungalvanized	1370/1770	74,6	0,517	56,9
7I130U602A	13	Sisal	Ungalvanized	1370/1770	87,6	0,607	66,6

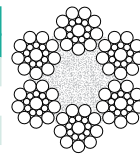

Hoist ropes - 8 x 19 Seale

Part Number	Diameter mm	Core	Surface	Tensile Strength N/mm ²	Min. Breaking Load kN	Net Weight kg/m	Metallic section mm ²
7I080U802A	8	Sisal	Ungalvanized	1370/1770	29,4	0,218	22,8
7I090U802A	9	Sisal	Ungalvanized	1370/1770	37,3	0,275	28,6
7I100U802A	10	Sisal	Ungalvanized	1370/1770	46,0	0,340	34,5
7I110U802A	11	Sisal	Ungalvanized	1370/1770	55,7	0,411	42,4
7I120U802A	12	Sisal	Ungalvanized	1370/1770	66,2	0,490	51,2
7I130U802A	13	Sisal	Ungalvanized	1370/1770	77,7	0,575	59,8
7I140U802A	14	Sisal	Ungalvanized	1370/1770	90,2	0,666	69,0
7I150U802A	15	Sisal	Ungalvanized	1370/1770	104	0,765	79,2
7I160U802A	16	Sisal	Ungalvanized	1370/1770	118	0,870	89,5



Wire Rope by Gustav Wolf

TO MEET DIN EN 12385, ISO 4344 AND BS 302-4 FOR F 819 S-FC DT - NOT AVAILABLE IN ALL MARKETS

Hoist and hoist / compensation F 819 S-FC DT - 8 x 19 Seale with natural fiber core

Part Number	Application	Diameter mm	Tensile Strength N/mm ²	Right Lay	Min. Breaking Load kN	Net Weight kg/m
621108010	Hoist	8,0	1370/1770	Regular	30,0	0,22
621109010	Hoist	9,0	1370/1770	Regular	38,4	0,28
621110010	Hoist	10,0	1370/1770	Regular	48,2	0,35
621111010	Hoist	11,0	1370/1770	Regular	58,4	0,43
621112010	Hoist	12,0	1370/1770	Regular	69,2	0,50
621113010	Hoist	13,0	1370/1770	Regular	80,7	0,59
621114010	Hoist	14,0	1370/1770	Regular	93,0	0,68
621115010	Hoist	15,0	1370/1770	Regular	108,0	0,78
621116010	Hoist	16,0	1370/1770	Regular	121,0	0,89
621118010	Hoist	18,0	1370/1770	Regular	154,0	1,11
621119011	Hoist	19,0	1370/1770	Regular	171,0	1,26
621120010	Hoist	20,0	1370/1770	Regular	188,0	1,40

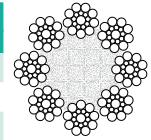

Recommended for low rise installations in light traffic applications. Particularly suitable for softer traction sheaves. Light and flexible, it offers an excellent service life.

Hoist PAWO F3 - 8 x 19 Seale with steel-reinforced natural fiber core

Part Number	Application	Diameter mm	Tensile Strength N/mm ²	Right Lay	Min. Breaking Load kN	Net Weight kg/m
761206531	Hoist	6,5	1570	Regular	25,9	0,16
761207031	Hoist	7,0	1570	Regular	29,4	0,19
761208031	Hoist	8,0	1570	Regular	38,0	0,24
761209031	Hoist	9,0	1570	Regular	48,3	0,31
761210032	Hoist	10,0	1570	Regular	60,5	0,39
761211031	Hoist	11,0	1570	Regular	73,4	0,47
761212031	Hoist	12,0	1570	Regular	86,8	0,55
761213031	Hoist	13,0	1570	Regular	103,1	0,66
761214031	Hoist	14,0	1570	Regular	119,3	0,76
761215031	Hoist	15,0	1570	Regular	137,6	0,86
761216031	Hoist	16,0	1570	Regular	154,8	0,98
761218031	Hoist	18,0	1570	Regular	193,6	1,23
761219031	Hoist	19,0	1570	Regular	217,6	1,38
761220031	Hoist	20,0	1570	Regular	241,5	1,53

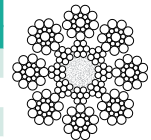

Recommended for low and mid-rise installations with normal to heavy usage levels. Wear-resistant, it offers low elongation and an extended service life.

Hoist PAWO 819W - 8 x 19 Warrington with IWRC for small sheaves with Type Examination Certificates

Part Number	Application	Diameter mm	Tensile Strength N/mm ²	Right Lay	Min. Breaking Load kN	Net Weight kg/m
741306532	Hoist	6,5	1770	Regular	31,5	0,17

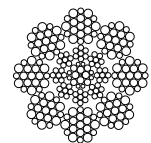

Metric governor - refer to specifications below

Part Number	Construction	Surface	Diameter mm	Tensile Strength N/mm ²	Right Lay	Min. Breaking Load kN	Net Weight kg/m
605306012	6 x 19 Standard 1 + 6 + 12	Galvanized	6,0	1770	Regular	21,0	0,12
605306030	6 x 19 Seale WSC	Galvanized	6,0	1770	Regular	26,0	0,15
601306510	6 x 19 Standard 1 + 6 + 12	Bright galvanized	6,5	1770	Regular	24,7	0,15
605306510	6 x 19 Seale	Bright	6,5	1570	Regular	25,8	0,16
591306510	6 x 19 Standard 1 + 6 + 12	Bright	6,5	1770	Regular	21,0	0,12
741306531	8 x 19 Warrington	Bright	6,5	1770	Regular	29,7	0,17
601308010	6 x 19 Standard 1 + 6 + 12	Bright	8,0	1770	Regular	37,4	0,22
761208031	8 x 19 Seale	Bright	8,0	1570	Regular	38,0	0,24

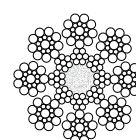
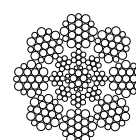
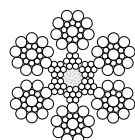
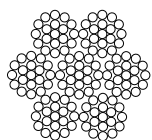
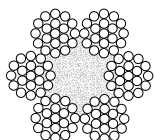

605306012
601306510

605306510
591306510

601308010

605306030

761206531

741306531

761208031

Wire Rope by Gustav Wolf

TO MEET DIN EN 12385, ISO 4344 - NOT AVAILABLE IN ALL MARKETS

PAWO F7 - 8 x 19 Warrington with steel-reinforced natural fiber core

Part Number	Application	Diameter mm	Tensile Strength N/mm ²	Right Lay	Min. Breaking Load kN	Net Weight kg/m
631208034	Hoist	8,0	1570	Regular	40,6	0,26
631209034	Hoist	9,0	1570	Regular	51,8	0,33
631210034	Hoist	10,0	1570	Regular	63,4	0,40
631211034	Hoist	11,0	1570	Regular	76,8	0,49
631212034	Hoist	12,0	1570	Regular	90,7	0,58
631213034	Hoist	13,0	1570	Regular	105,0	0,67
631214034	Hoist	14,0	1570	Regular	124,3	0,79
631215034	Hoist	15,0	1570	Regular	139,9	0,89
631216034	Hoist	16,0	1570	Regular	160,4	1,02
631218034	Hoist	18,0	1570	Regular	201,2	1,28
631219034	Hoist	19,0	1570	Regular	225,6	1,43
631220034	Hoist	20,0	1570	Regular	250,1	1,59

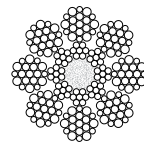

Steel-reinforced natural fiber core provides reduced stretch and cross-section deformation with higher breaking strength. More flexible eight-strand/Warrington construction resists rope fatigue due to bending in installations with numerous rope bends.

PAWO F7S - 8 x 19 Warrington with Independent Wire Rope Core

Part Number	Application	Diameter mm	Tensile Strength N/mm ²	Right Lay	Min. Breaking Load kN	Net Weight kg/m
631208033	Hoist	8,0	1570	Regular	44,6	0,28
631209032	Hoist	9,0	1570	Regular	56,0	0,36
631210033	Hoist	10,0	1570	Regular	69,5	0,44
631211032	Hoist	11,0	1570	Regular	83,1	0,53
631212032	Hoist	12,0	1570	Regular	98,9	0,63
631213033	Hoist	13,0	1570	Regular	116,0	0,73
631214031	Hoist	14,0	1570	Regular	134,8	0,86
631215032	Hoist	15,0	1570	Regular	152,8	0,97
631216032	Hoist	16,0	1570	Regular	176,1	1,11
631218031	Hoist	18,0	1570	Regular	218,6	1,39
631219031	Hoist	19,0	1570	Regular	245,2	1,56
631220031	Hoist	20,0	1570	Regular	270,8	1,72

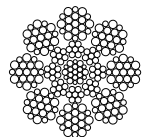

Full steel core (IWRC) reduces stretch and cross-section deformation to a minimum while maximizing breaking strength. More flexible eight-strand/Warrington construction resists rope fatigue due to bending in installations with numerous rope bends and smaller sheaves. PAWO F7S comes with a green surface line.

PAWO F10 - 9 x 17 Filler Wire with Independent Wire Rope Core

Part Number	Application	Diameter mm	Tensile Strength N/mm ²	Right Lay	Min. Breaking Load kN	Net Weight kg/m
721208032	Hoist	8,0	1570	Regular	43,2	0,27
721209031	Hoist	9,0	1570	Regular	54,8	0,34
721210032	Hoist	10,0	1570	Regular	67,2	0,42
721211032	Hoist	11,0	1570	Regular	80,2	0,51
721212032	Hoist	12,0	1570	Regular	95,6	0,60

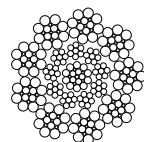

Designed specifically for demanding high-rise/high-speed applications using rope diameters of 8.0 to 12.0 mm. Full steel core (IWRC) and nine-strand/Filler Wire construction work together to achieve minimal stretch, a round cross-section, excellent flexibility, increased resistance to rope fatigue due to bending and maximized breaking strength. PAWO F10 comes with a white surface line.

PAWO F10 - 9 x 21 Filler Wire with Independent Wire Rope Core

Part Number	Application	Diameter mm	Tensile Strength N/mm ²	Right Lay	Min. Breaking Load kN	Net Weight kg/m
721213032	Hoist	13,0	1570	Regular	113,4	0,71
721214031	Hoist	14,0	1570	Regular	135,7	0,85
721215031	Hoist	15,0	1570	Regular	140,3	1,00
721216032	Hoist	16,0	1570	Regular	174,0	1,08
721218030	Hoist	18,0	1570	Regular	219,7	1,37
721219031	Hoist	19,0	1570	Regular	244,9	1,52
721220031	Hoist	20,0	1570	Regular	250,0	1,78

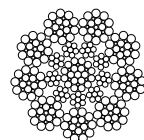

Designed specifically for demanding high-rise/high-speed applications using rope diameters of 13.0 mm and larger. Full steel core (IWRC) and nine-strand/Filler Wire construction work together to achieve minimal stretch, a round cross-section, excellent flexibility, increased resistance to rope fatigue due to bending and maximized breaking strength. PAWO F10 comes with a white surface line.

Wire Rope Wedge Sockets

TO MEET EN 13411-7

Wire rope wedge sockets - symmetrical

Part Number	Rope size mm	Z	A	B	C	D	I	Q	R
10250	4 to 5	346	150	M10	8,8	250	96	n/a	n/a
10250C	4 to 5	346	150	M10	8,8	250	96	60	24
12200	6 to 8	330	150	M12	11	200	130	n/a	n/a
12200C	6 to 8	330	150	M12	11	200	130	128	33
12300	6 to 8	430	160	M12	11	300	130	n/a	n/a
12300C	6 to 8	430	160	M12	11	300	130	144	29
12400	6 to 8	530	160	M12	11	400	130	n/a	n/a
12400C	6 to 8	530	160	M12	11	400	130	144	29
16300	9 to 11	464	155	M16	15	300	164	n/a	n/a
16300C	9 to 11	464	155	M16	15	300	164	144	29
16400	9 to 11	564	155	M16	15	400	164	n/a	n/a
16400C	9 to 11	564	155	M16	15	400	164	144	29
16500	9 to 11	664	155	M16	15	500	164	n/a	n/a
16500C	9 to 11	664	155	M16	15	500	164	144	29
20300	12 to 14	498	150	M20	18	300	198	n/a	n/a
20300C	12 to 14	498	150	M20	18	300	198	144	29
20400	12 to 14	598	150	M20	18	400	230	n/a	n/a
20400C	12 to 14	598	150	M20	18	400	230	144	29
20500	12 to 14	698	150	M20	18	500	230	n/a	n/a
20500C	12 to 14	698	150	M20	18	500	230	144	29

Each wedge socket consists of the socket, rod, wedge, 2 nuts, 1 washer, 1 cotter pin and 2 retaining clips. Those with a "C" in the part number come with isolation bushings.

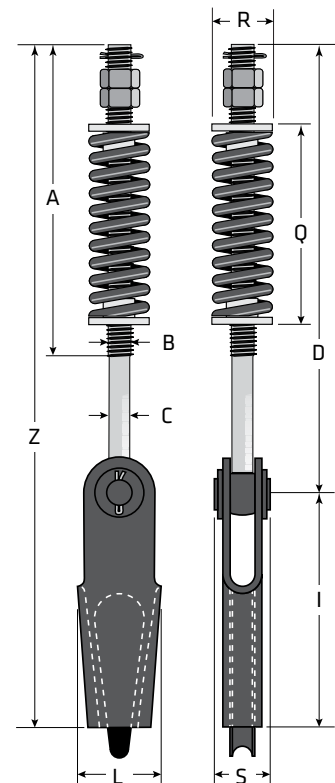

Wire rope wedge sockets - asymmetrical

Part Number	Rope size mm	A	B	D	F	L	Spring Compression Force Max (N)
10090	5 to 6,5	n/a	n/a	n/a	n/a	n/a	n/a
10090C	5 to 6,5	n/a	n/a	24	6	90	2600
10100C	5 to 6,5	22	55	18	2,5	100	350

Each wedge socket consists of the socket, rod, wedge, 2 nuts, 1 washer, 1 cotter pin and 2 retaining clips. Those with a "C" in the part number come with isolation bushings.

10100C has a sleeve inside the bushing spring.

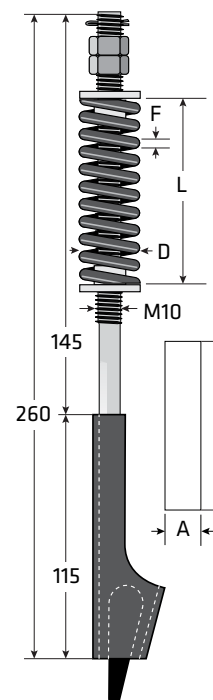

Wire Rope Wedge Sockets

TO MEET ASME A17.1 / CSA B44

Wire rope wedge sockets

Part Number	Rope size mm	Dim (A) nom mm (+/- 5)	Dim (B) nom mm (+/- 5)	Dim (C) Thread and Diameter	Usable Thread min mm	Dim (D) nom mm (+/- 10)
WSY-516-12	8	445	320	M12	200	225
WSY-516-18	8	605	480	M12	250	275
WSY-516-24	8	765	640	M12	400	425
WSY-38-12	9 to 10	445	320	M12	200	225
WSY-38-18	9 to 10	605	480	M12	250	275
WSY-38-24	9 to 10	765	640	M12	400	425
WSY-12-12-A	11 to 13	457	320	M20	200	225
WSY-12-18-A	11 to 13	619	480	M20	250	275
WSY-12-24-A	11 to 13	778	640	M20	400	425
WSY-12-30-A	11 to 13	937	800	M20	400	425
WSY-12-36-A	11 to 13	1099	960	M20	400	425
WSY-58-12	14 to 16	502	320	M20	200	225
WSY-58-18	14 to 16	664	480	M20	250	275
WSY-58-24	14 to 16	822	640	M20	400	425
WSY-58-30	14 to 16	984	800	M20	400	425
WSY-58-36	14 to 16	1143	960	M20	400	425
WSY-34-12	17,5 to 19	540	320	M24	200	225
WSY-34-18	17,5 to 19	699	480	M24	250	275
WSY-34-24	17,5 to 19	857	640	M24	400	425
WSY-34-30	17,5 to 19	1010	800	M24	400	425
WSY-34-36	17,5 to 19	1175	960	M24	400	425

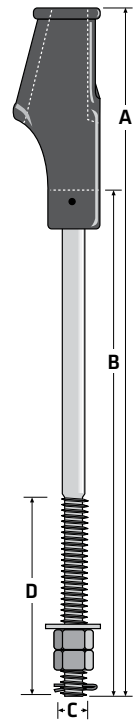

Each wedge socket consists of the socket, rod, wedge, 2 nuts, 1 washer, 1 cotter pin and 2 retaining clips.

Draka wedge sockets are tested with steel core (IWRC) wire rope and exceed ASME A17.1 Rule 2.20.9 and all other applicable safety codes.

Component Specifications:

Socket: Cast steel ASTM-A27, Grade 60-30 stress relieved

Rod: Rolled or forged steel ASTM 668

Wedge: Cast steel ASTM-A27, Grade 60-30

Governor rope wedge sockets

Part Number	Description
WSY-38-GOV	10 mm governor rope wedge socket, includes socket, wedge & 2 retaining clips, 14 mm mounting hole
WSY-12-GOV	13 mm governor rope wedge socket, includes socket, wedge & 2 retaining clips, 17,5 mm mounting hole



Guide Rail Clips

Guide rail clips - galvanized

Part Number	Style	A	B	C	D	E	F	G	H	M
BT1Z	T1	21	31	13	5,5	12	6	10,5	30	10
BT2Z	T2	24	38	18	7,0	15	7	12,0	32	12
BT3Z	T3	28	42	21	8,5	17	8	13	38	14
BT4Z	T4	32	50	22	10,5	20	9	15	42	16
BT5Z	T5	36	54	26	13	23	11	16	44	18

Guide rail clips are supplied in packs of 10 pieces including:

- nut to UNI 5588 Zn 8.8
- flat washer to UNI 6592 ZN
- spring washer to UNI 1751.

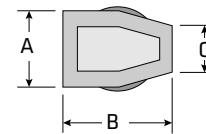
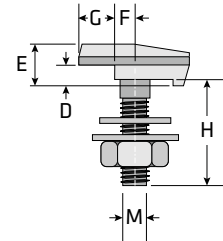

Wire Rope Lubrication

Acculube™ automatic rope lubricator and cleaner kit

Part Number	Description
ACCULUBE 200	Automatic rope lubricator/cleaner kit, with three brushes (210 mm pan), bracket and reservoirs filled with DrakaLube wire rope treatment
ACCULUBE 300	Automatic rope lubricator/cleaner kit, with three brushes (300 mm span), bracket and reservoirs filled with DrakaLube wire rope treatment
SLX125 DRAKALUBE	Replacement lubricator reservoir, filled with DrakaLube
2036	One (1) replacement 70 mm brush for Acculube 200
2037	One (1) replacement 100 mm brush for Acculube 300
98-02-87	One (1) steel mounting bracket
1015	One (1) reservoir attachment nipple

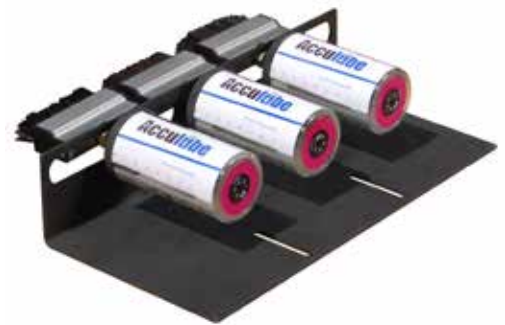

The Acculube automatic rope lubricator/cleaner is a set-and-forget way of efficiently lubricating traction ropes for up to a year.

The unit is quickly and easily assembled in the machine room. Simply install it so that the brushes are in contact with the ropes, set the lubricators to the proper time setting for your application (one year for standard indoor elevators, six months for exterior or high-contaminant environments) and walk away knowing that your hoist ropes are being consistently treated and cleaned as the elevator operates.

The lubricator reservoirs come pre-filled with our specially-formulated DrakaLube™ rope treatment. Please note that if your ropes are dirty, there will be greasy residue at the unit for a short while as the Acculube unit does its job.

Features

- Labor and time-saving way to keep ropes lubricated
- No oil spills or splashes in the machine room or the car
- Easy installation
- Constant, reliable lubricant application
- Ropes are continually cleaned by the brushes

DrakaLube™ wire rope treatment / lubricant

Part Number	Description
WR-DRAKALUBE	DrakaLube wire rope treatment / lubricant, 4 litre jug

DrakaLube wire rope treatment / lubricant has been specifically formulated to fight bending stresses, high groove pressures and moisture. DrakaLube has additives that protect against corrosion, wear and most importantly, it can also displace moisture in the rope core.



Rope oilers for elevator hoist ropes, escalator chains and selector tapes

Part Number	Description
MIS-100	Automatic oiler, with 229 mm wick
MIS-102	Automatic oiler, with 304 mm wick
MIS-103	Extension bracket, for rope oiler
MIS-103A	Replacement wick, for all size rope oilers
MIS-103B	Replacement wick, 13 x 165 x 304 mm

The rope oiler lubricates by electrostatic attraction and requiring only minimal wick adjustment after installation.

Features

- Automatically lubricates rope for increased rope and sheave life
- Has an adjustable oiling rate-wick lock and wick length
- Features a top-fill external oil level indicator

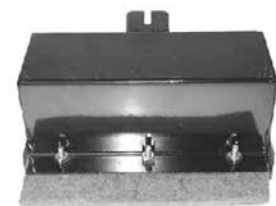

Rope Tensioning System

MICELECT RTS ROPE TENSIONING SYSTEMS - NOT AVAILABLE IN ALL MARKETS

RTS rope tensioning system

Part Number	Description
WR-RTS	RTS system, including control unit, power supply, USB cable for PC connection, T-handle allen wrench (for attaching sensors to rope), six (6) sensors and hard-shell case.
WR-WRS	Additional wire rope sensor and couplings for 1/6 - 5/8 in (4 - 16 mm) wire rope. Order one per rope.

The Micelect RTS (Rope Tensioning System) is a portable tool for quickly and accurately measuring the tension of elevator wire ropes. Rope tensions are quickly displayed on a backlit LCD screen.

Operating the RTS is simple: Small sensors (six are included) are attached to each wire rope using the supplied T-handle allen wrench. USB cables connect the sensors to the RTS control unit which displays rope tension in real time, allowing the tensions to be adjusted. Additional sensors are available.

Pre- and post-adjustment values are stored in the RTS memory and can be downloaded to a PC for accurate record keeping.

Features

- Portable
- Readout in both pounds and kilograms
- Accurate to within 3%
- Can be used to measure both rope tension and weight of the car and counterweight
- Can measure up to 12 ropes at once with a maximum weight of 2200 lbs • 1000 kg per rope
- Both graphic and numeric displays
- Fits 1/6 to 5/8 in • 4 to 16 mm ropes
- Display languages include English, Spanish, German, Italian, French and Portuguese
- Comes with all cables, T-handled allen wrench and a hard-shell case
- Six sensors are included, can handle as many as twelve
- Stores and downloads to PC pre- and post-tensioning values
- Low battery indicator
- Factory reset switch



Heavy duty RTS rope tensioning system

Part Number	Description
WR-RTS-A	Heavy duty RTS system, including control unit, power supply, USB cable for PC connection, T-handle allen wrench (for attaching sensors to rope), six (6) sensors and hard-shell case.
WR-WRS-A	Additional wire rope sensor and couplings for 1/2 - 3/4 in (13 - 20 mm) wire rope. Order one per rope.

The heavy duty version of the RTS is for higher-capacity elevators with larger hoist ropes. It has all of the features of the standard RTS but with a sensor that fits 1/2 to 3/4 in • 13 to 20 mm ropes. Maximum weight per rope is 3000 kg • 6600 lbs. Spacers to fit the various rope diameters are included.

Features

- Portable
- Readout in both pounds and kilograms
- Accurate to within 3%
- Can be used to measure both rope tension and weight of the car and counterweight
- Can measure up to 12 ropes at once with a maximum weight of 3000 lbs • 1360 kg per rope
- Both graphic and numeric displays
- Fits 1/2 to 3/4 in • 13 to 20 mm ropes
- Display languages include English, Spanish, German, Italian, French and Portuguese
- Comes with all cables, T-handled allen wrench and a hard-shell case
- Six sensors are included, can handle as many as twelve
- Stores and downloads to PC pre- and post-tensioning values
- Low battery indicator
- Factory reset switch



Rope Tensioning System

MICELECT RTS RF - NOT AVAILABLE IN ALL MARKETS

RTS RF wireless rope tensioning system

Part Number	Description
WR-RTS-RF	Wireless RTS system, including control unit, recharging cable, T-handle allen wrench (for attaching sensors to rope), six (6) WR-WRF small sensors and hard-shell case.
WR-WRF	Additional wire rope sensor

The Micelect wireless RTS RF does not require a physical connection between the sensors and the control unit. Rope tensions are displayed in real time on a backlit LCD screen. Operating range is 10 meters • 33 ft. Depending on the configuration, sensors fit rope sizes from 3/16 to 7/16 in • 4 to 11 mm and 1/2 to 3/4 in • 13 to 20 mm. Parts are included for both sizes.

Like the wired RTS, small rechargeable sensors (six are included in the basic kit) are attached to individual ropes using the supplied T-handle allen wrench. The sensors communicate with the control unit via radio and are accurate to within 5% of actual load. Additional sensors are available. The control unit can receive signals from up to twelve sensors.

Pre- and post-adjustment values are stored in the RTS memory and can be downloaded to a PC for accurate record keeping.

Features

Fits 3/16 to 3/4 in • 4 to 20 mm

No wiring required

Readout in both pounds and kilograms

Accurate to within 5%

Can be used to measure both rope tension and weight of the car and counterweight

Sensor maximum capacity is 6600 lbs • 3000 kg



Load Weighing Devices

LMC LOAD WEIGHING DEVICE - INSTALLS IN THE OVERHEAD - NOT AVAILABLE IN ALL MARKETS

LMC load weighing device



Part Number	Description
LW-LMC	Load weighing device (sensor only), for 1:1 (8,800 lbs • 4000 kg), 2:1 (17,600 lbs • 8,000 kg) or 4:1 roping (35,200 lbs • 16,000 kg) capacity (please call if higher capacity is needed), automatic calibration, accurate to within 5%. Select spacers and clamps (below) and optional cab display (see page 66)



The LMC intelligent wire rope sensor is a precise device for monitoring the load in traction elevators. It mounts on the hoist ropes in the overhead in as little as five minutes - calibration is automatic and no test weights are required. It's perfect for modernizations as well as for new installations.

The LMC requires an LM3D control unit (see next page). Clamps and spacers (sold separately) are determined by the spread of the ropes. A cab display that shows overload condition is available as an option.

Features

- Operating capacity up to 35,200 lbs. for 4:1 roping (17,600 kg for 2:1 roping, 8,800 for 1:1 roping)
- Accurate to within 0.5%
- Fast, easy installation
- Suitable for wire ropes from 3/8 to 3/4 in. • 6 to 20 mm diameter.
- Choose either digital or analog (0-20 mA, 0-24 mA, 4-20 mA) output

Heavy duty LMC-REF load weighing device



Part Number	Description
LW-LMC-REF	LMC-style load weighing device for heavier applications for 1:1 (16,500 lbs • 7,500 kg), 2:1 (33,000 lbs • 15,000 kg) and 4:1 (66,000 • 30,000 kg) cab weight (cab weight + cargo + compensation) - Select spacers and clamps (below) Can accommodate rope spreads of up to 8-1/2 in. • 226 mm and rope diameters up to 3/4 in. • 19 mm



The Micelect LMC-REF load weighing device is designed for heavier applications, such as freight elevators or larger passenger cars. It can determine weights up to 16,500 lbs • 7,500 kg in 1:1 roping and more in 2:1 and 4:1 roping schemes. The LMC-REF is an enhancement over the standard LMC device in that it features a special humidity-resistant housing for extended life and reliability while carrying an IP65 rating.

The LMC-REF requires an LM3D control unit (see page 66). Clamps and spacers (sold separately) are determined by the spread of the ropes. NOTE: Test weights are required for calibration.

Features

- Operating capacity up to 30000 kg for 4:1 roping (15000 kg for 2:1 roping)
- Fast, easy installation
- Choose either digital or analog (0-20 mA, 0-24 mA, 4-20 mA) output

Clamps for LMC and LMC-REF load weighing devices

Part Number	Description
LW-LMC-CLAMP-4	LW-LMC size 4 clamp, up to 6-1/4 in. • 160 mm of rope spread, two LW-SPACER required
LW-LMC-CLAMP-5	LW-LMC size 5 clamp, 6-3/8 to 7-3/8 in. • 161 to 188 mm of rope spread, four LW-SPACER required
LW-LMC-CLAMP-6	LW-LMC size 6 clamp, 7-1/2 to 8-1/2 in. • 189 to 226 mm of rope spread, four LW-SPACER required
LW-LMC-CLAMP-4-REF	LW-LMC-REF size 4 clamp, up to 6-1/4 in. • 160 mm of rope spread, two LW-SPACER required
LW-LMC-CLAMP-5-REF	LW-LMC-REF size 5 clamp, 6-3/8 to 7-3/8 in. • 161 to 188 mm of rope spread, four LW-SPACER required
LW-LMC-CLAMP-6-REF	LW-LMC-REF size 6 clamp, 7-1/2 to 8-1/2 in. • 189 to 226 mm of rope spread, four LW-SPACER required

Spacers for LMC and LMC-REF load weighing devices

Part Number	Description
LW-SPACER-38	Spacer for LMC, 3/8 in. • 10 mm, two required for CLAMP- and CLAMP-REF-4, four for 5 and 6
LW-SPACER-12	Spacer for LMC, 1/2 in. • 13 mm, two required for CLAMP- and CLAMP-REF-4, four for 5 and 6
LW-SPACER-58	Spacer for LMC, 5/8 in. • 16 mm, two required for CLAMP- and CLAMP-REF-4, four for 5 and 6
LW-SPACER-1116	Spacer for LMC, 11/16 in. • 17.5 mm, two required for CLAMP- and CLAMP-REF-4, four for 5 and 6
LW-SPACER-34	Spacer for LMC, 3/4 in. • 19 mm, two required for CLAMP- and CLAMP-REF-4, four for 5 and 6

Load Weighing Devices

NON-WIRE ROPE WEIGHING DEVICES, CONTROL UNITS AND CAB DISPLAYS - NOT AVAILABLE IN ALL MARKETS

Under cab sensor



Part Number	Description
LW-CAB-SENSOR	Under cab sensor, sold in multiples of 2 (4 to 16 may be used), features automatic calibration

Under cab sensors are ideal for new installations. They easily mount under the cab and are extremely accurate. They are self-calibrating and do not require test weights. An LM3D-EMC-CSA control unit is required (see below).

Under cab sensors are not recommended for modernizations.



Belt sensor



Part Number	Description
023-4-0003	Belt sensor, for individual 1/8 in. • 3 mm belts (sensor only), attaches to individual belts, operating capacity 2645 lbs • 1200 kg per belt.
023-4-0004	Belt sensor, for individual 3/16 in. • 4.6 mm belts (sensor only), attaches to individual belts, operating capacity 2645 lbs • 1200 kg per belt.

Up to eight belt sensors can be attached to a required LM3D-EMC-CSA control unit (see below).

Test weights are presently required for calibration - automatic calibration is pending.



LM3D control unit

Part Number	Description
LM3D-EMC-CSA	Control unit for LMC with three relay outputs and one 0-20, 4-20 or 0-24 mA analog output, 115VAC
LM3D-EMC-CSA-5V	Control unit for LMC with three relay outputs and one voltage (not current) analog output, 115VAC
LM3D-EMC-CSA-220	Control unit for LMC with three relay outputs and one 0-20, 4-20 or 0-24 mA analog output, 220VAC

The LM3D control unit is the brain of the Micelect LWD family. The LM3D relays indicate “presence,” “full” and “overload” conditions to trigger appropriate controller response. The presence relay can be used to eliminate nuisance calls. A cab display that shows overload condition is available as an option (see below). Integrated software automatically corrects for increases in load caused by compensating cable or chain.

For the LM3D unit, choose either digital or analog (0-20 mA, 0-24 mA, 4-20 mA) output.

Features

- Three programmable alarm values (Presence, Full Load and Overload)
- Weight is visually displayed
- Built-in memory saves data
- Simple programming - just four keys program all parameters



Cab displays







Part Number	Description
LW-CABDISPLA-ML	Cab display, overload shown by flashing and intermittent buzzing
LW-CABDISPLA-LPM	Cab display, load shown by progressively lit LEDs, overload by flashing and intermittent buzzing This display cannot be used with LM-ILC3-M-ANLOG



Compensation Products Comparison

SELECT THE PRODUCT FOR YOUR NEEDS

Compensation cables

Part Series	Operating speed (max)	Loop Width	Construction	Warranty
Whisper-Flex®	✓✓✓✓	Standard	 Round / Chain	✓✓✓✓
	3,56 m/sec	610/690 mm	Metallic bead core / PVC sheath	Lifetime
Steady-Flex®	✓✓✓✓	Wide	 Round / Chain	✓✓✓✓
	3,56 m/sec	970/1270 mm	Metallic bead core / PVC sheath	Lifetime
QuietLink II™	✓✓✓✓	Standard	 Round / Chain	✓
	3,56 m/sec	610/690 mm	PVC sheath	One year
Easy-Balance™	✓✓	Narrow	 Chain	✓
	1,75 m/sec	< 320 mm	PVC sheath	One year

Note on loop widths:

Steady-Flex is made especially for installations with balance concerns such as side counterweights and long hanging lengths.

Easy-Balance has a narrow loop width similar to compensation chains.

Draka Elevator can help you determine which size of Whisper-Flex, Steady-Flex or QuietLink II cable to use.

Please give us this information in your communication:

- 1) number of hoist ropes per car
- 2) outer diameter of the hoist ropes
- 3) stranding of the hoist ropes (i.e. 8 x 19, 8 x 25...)
- 4) car roping (i.e. 1:1, 2:1, other...)
- 5) number of Whisper-Flex cables per car
- 6) length of Whisper-Flex cable needed.

If replacing existing compensation, have ready the chain link size or cable brand name and outer diameter.

Whisper-Flex® Compensation Cable

LIFETIME WARRANTY - PATENT NUMBER 4716989

US patent 4,716,989

LIFETIME WARRANTY

Part Number	Product Code	Cable Weight kg/m	Chain Trade Size mm	Cable Nom. OD mm	Max. Hang Length meters	Norm. Loop Width mm
18-075-97	WF 075	1,1	5,5	27	183	540
18-010-97	WF 10	1,5	5,5	29	183	610
18-015-97	WF 15	2,2	7	35	183	610
18-020-97	WF 20	3,0	7	38	158	660
18-025-97	WF 25	3,7	8	41	183	660
18-030-97	WF 30	4,5	8	45	154	660
18-035-97	WF 35	5,2	10	49	183	690
18-040-97	WF 40	6,0	10	52	162	90



Whisper-Flex cable provides smooth operation at temperatures of -15° C to +60° C and can be used for elevators with rated speeds of no greater than 3,56 m/sec.

Support brackets, U-bolts, S-hooks, and heavy duty stainless steel grips specifically designed for Whisper-Flex cable must be used to ensure safe installations. See page 48 for details on this hardware.

Draka Elevator damping devices are recommended to minimize cable sway for car speeds above 1,8 m/sec. See page 50 for information on these devices.

This diagram shows the approximate placement of components for a Whisper-Flex cable installation. Refer to Draka's Compensation Cable Installation Guide for exact instructions on installation procedures.

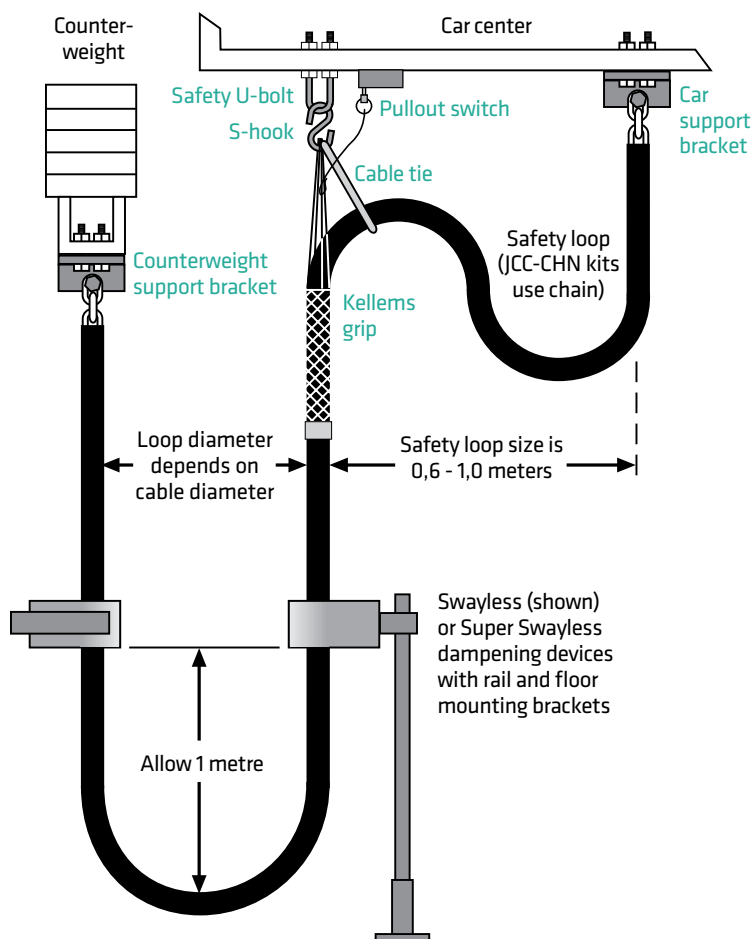

Stripping service 1 1/2 or 3 1/2 links exposed

Part Number	Description
WFSTRIP1.5L	Cable with 1-1/2 links stripped at one end
WFSTRIP3L	Cable with 3-1/2 links stripped at one end

Pullout Switch and Installation Kit

Part Number	Description
36-207	Pullout switch, with flat key actuator and rotating head
WF-POSK	Pullout switch installation kit, which includes one pullout switch (#36-207), two split O-rings, two cable ties, two 4 x 40 mm pan-head screws, two 4 mm hex nuts, four 4 mm flat washers and two 4 mm lock washers.

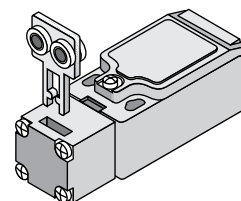

The pullout switch is UL and C-UL listed and conforms to EN1088, EN292, EN60947-5-1, EN60204-1 and EN50047. The switch enclosure meets NEMA 6.

Steady-Flex® Compensation Cable

LIFETIME WARRANTY - USE WITH SIDE COUNTERWEIGHTS AND LONG (> 400 FT • 122 M) HANG LENGTHS

US patent 7,610,944 • European patent 1721859

LIFETIME WARRANTY

Part Number	Product Code	Cable Weight kg/m	Chain Trade Size mm	Cable Nom. OD mm	Max. Hang Length metres	Dynamic Loop Width mm
18-L15-97	SFC 15	2,2	7	35	183	1170
18-L20-97	SFC 20	3,0	7	40	158	1200
18-L25-97	SFC 25	3,7	8	42	183	220
18-L30-97	SFC 30	4,5	8	46	154	1250
18-L35-97	SFC 35	5,2	10	49	183	1270
18-L40-97	SFC 40	6,0	10	52	162	1270



Steady-Flex cable is a **wide-loop version** of our standard Whisper-Flex compensation cable. Because of its wider natural loop, Steady-Flex cable can be positioned closer to the car's centerline. This improves car balance and ride quality for installations with side counterweights and long hang lengths (over 122 m).

It provides smooth operation at temperatures of -15° C to +60° C and can be used for elevators with rated speeds up to 3,56 m/sec.

Support brackets, U-bolts, S-hooks and heavy duty couplings specifically designed for Steady-Flex cable must be used to ensure safe installations. Installation hardware (JCC-XX-CHN) is recommended for use with Steady-Flex. See page 48 for details on this hardware.

Draka Elevator's Super Swayless (p/n WF-RDD3-S) damping device is recommended for use with Steady-Flex to minimize cable sway for car speeds above 1,8 m/sec. See page 52.

Steady-Flex installation and the dynamic loop width

When choosing Steady-Flex, give special consideration to the dynamic loop width. The dynamic loop width is the width of the loop when the cable is in motion and will vary with car speed, distance between support points and other factors. The static loop width will be up to 250 mm smaller. Position the attachment points and damping devices per the dynamic loop width in the above table. At rest, the cable should touch the damping device inside rollers - in motion, the loop will expand.

Steady-Flex is NOT a one-for-one replacement for Whisper-Flex. Pit dimension and possible obstructions should be considered when specifying Steady-Flex. Counterweight and car attachment points should be spaced to match the dynamic loop width.

Refer to the Draka technical bulletin "Special considerations for selecting and installing Steady-Flex compensation cable" for exact instructions on installation procedures.

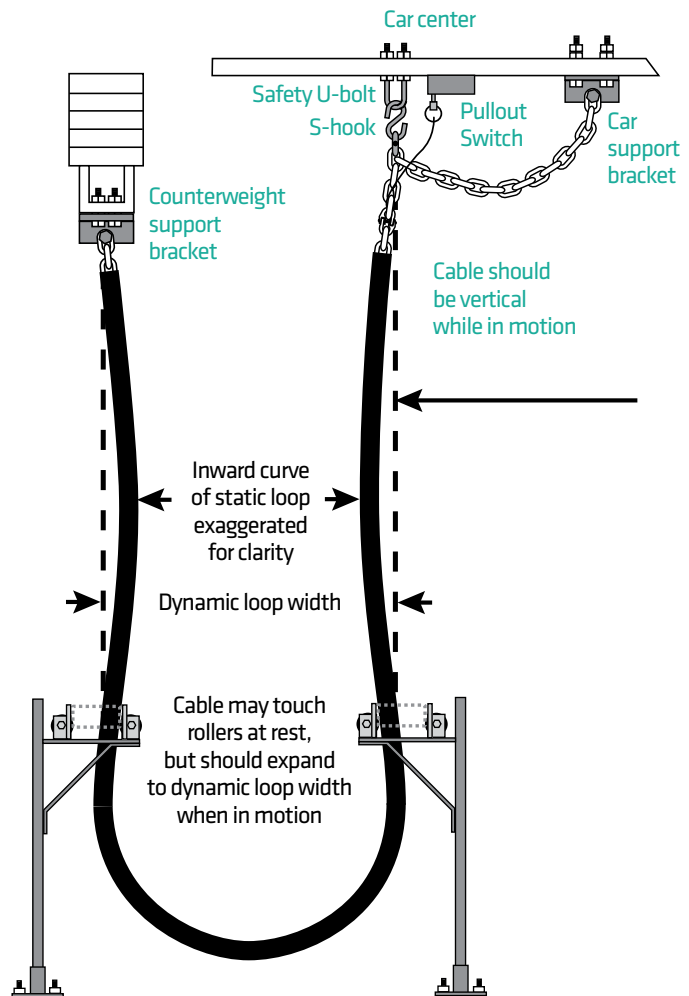

Stripping service 1 1/2 or 3 1/2 links exposed

Part Number	Description
WFSTRIP1.5L	Cable with 1-1/2 links stripped at one end
WFSTRIP3L	Cable with 3-1/2 links stripped at one end

Compensation Cable Installation Kits

INSTALLATION KITS FOR WHISPER-FLEX AND STEADI-FLEX

JCCML kits for Whisper-Flex cables

Part Number	For Use on Cables	U-bolt Size	S-hook Part No.	Mesh grip Part No.	Electrical Tape Part No.
JCCML-10	WF 075 and WF 10	10 mm	79-011	024-20-1504	16-005
JCCML-15	WF 15	10 mm	79-013	024-20-1470	16-005
JCCML-20	WF 20	10 mm	79-013	024-20-1510	16-005
JCCML-25	WF 25	12 mm	79-016	024-20-1510	16-005
JCCML-30	WF 30 and WF 35	12 mm	79-016	024-20-1499	16-005
JCCML-40	WF 40	12 mm	79-016	024-20-1542	16-005

JCCML installation kits contain three U-bolts (includes nuts and washers), one S-hook, a mesh grip and electrical tape.

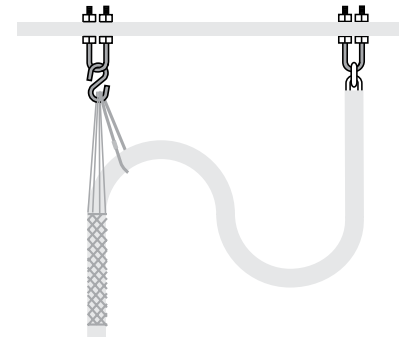

JCC-CHN kits for Steadi-Flex (and Whisper-Flex in shallow pits)

Part Number	For Use on Cables	U-bolt Size	S-hook Part No.	Coupling Quantity/Size	Chain Size
JCC-10-CHN	WF 075 WF 10	9,5 mm	79-011	(1) 7 mm	8 mm
JCC-20-CHN	WF 15 & 20 SFC 15 & 20	9,5 mm	79-013	(1) 7 mm	8 mm
JCC-30-CHN	WF 25 & 30 SFC 25 & 30	9,5 mm	79-016	(2) 7 mm	9,5 mm
JCC-40-CHN	WF 35 & 40 SFC 35 & 40	9,5 mm	79-016	(1) 7 mm, (1) 9,5 mm	9,5 mm

JCC-CHN installation kits contain two Support Brackets (includes grade 8 nuts, bolts, lock-washers and hardened washers), one U-bolt (includes nuts and washers) and one S-hook. JCC-CHN kits also include one or two couplings and a 1,2 metre length of chain to form the safety/adjustment loop.

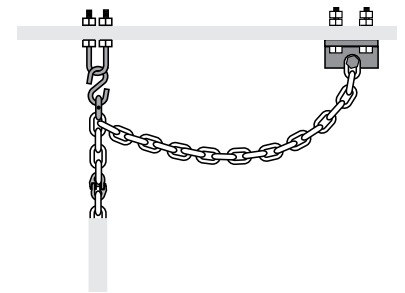

Coupling kits for shallow pits

Part Number	For Use on Compensation Cable	Chain Size Quantity and Size	Coupling
WF-20-CPLG	WF 075/SFC 15 & 20	8 mm.	(1) 7 mm
WF-30-CPLG	WF/SFC 25 & 30	9,5 mm	(2) 7 mm
WF-40-CPLG	WF/SFC 35 & 40	9,5 mm	(1) 7 mm, (1) 9,5 mm

Coupling kits consist of the chain and coupling(s) from the JCC-CHN installation kits. They DO NOT include mounting brackets, U-bolts or S-hooks.



IMPORTANT NOTE ON SAFETY AND WARRANTY FOR WHISPER-FLEX AND STEADI-FLEX:
 These components are specifically designed for the installation of Whisper-Flex/Steady-Flex cables. ONLY THE S-HOOK, MESH GRIP AND COUPLINGS ARE AVAILABLE SEPARATELY. USE OF OTHER HARDWARE (non-Draka Elevator components) COULD SERIOUSLY JEOPARDIZE THE SAFETY OF THE WHISPER-FLEX OR STEADI-FLEX CABLE INSTALLATION AND WILL VOID ANY WARRANTY.

QuietLink™ II Compensation Cable

METRIC CABLE AND INSTALLATION KITS

QuietLink cables

Product Code	Cable Weight kg/m	Chain Trade Size (nom. ± 0.5) mm	Cable Nom. OD mm	Max. Hang Length meters	Nom. Loop Width mm
QL075	1,12	6,0	24	160	610
QL10	1,49	6,5	27	160	610
QL125	1,88	7,0	30	160	610
QL15	2,24	7,8	32	150	610
QL20	2,98	9,0	38	160	660
QL25	3,73	10	42	150	660
QL30	4,47	11	44	150	660
QL35	5,22	12	48	150	690
QL40	5,96	13	52	150	690



QuietLink II cable provides smooth operation at temperatures of -15° C to +60° C, and can be used for elevators with rated speeds of up to 3,5 m/sec. It is similar in construction to Whisper-Flex only without the metallic beads in the filler/jacket.

Support brackets, U-bolts, shackles, heavy-duty stainless steel grips and/or other devices should be used to ensure safe installations. See page 48 for details on this hardware.

Draka Elevator damping devices are recommended to minimize cable sway for car speeds above 1,78 m/sec. See page 52 for information on these devices.

This diagram shows the approximate placement of components for a QuietLink II cable installation (similar to those in the Whisper-Flex Installation Guide). Refer to the Compensation Cable Installation Guide for exact instructions on installation procedures.

Draka Elevator can help you determine which size of QuietLink II cable to use. Call your regional representative and have the following information ready:

- 1) number of hoist ropes per car
- 2) outer diameter of the hoist ropes
- 3) stranding of the hoist ropes (i.e. 8x19, 8x25...)
- 4) car roping (i.e. 1:1, 2:1, other...)
- 5) number of QuietLink II cables per car
- 6) length of QuietLink II cable needed

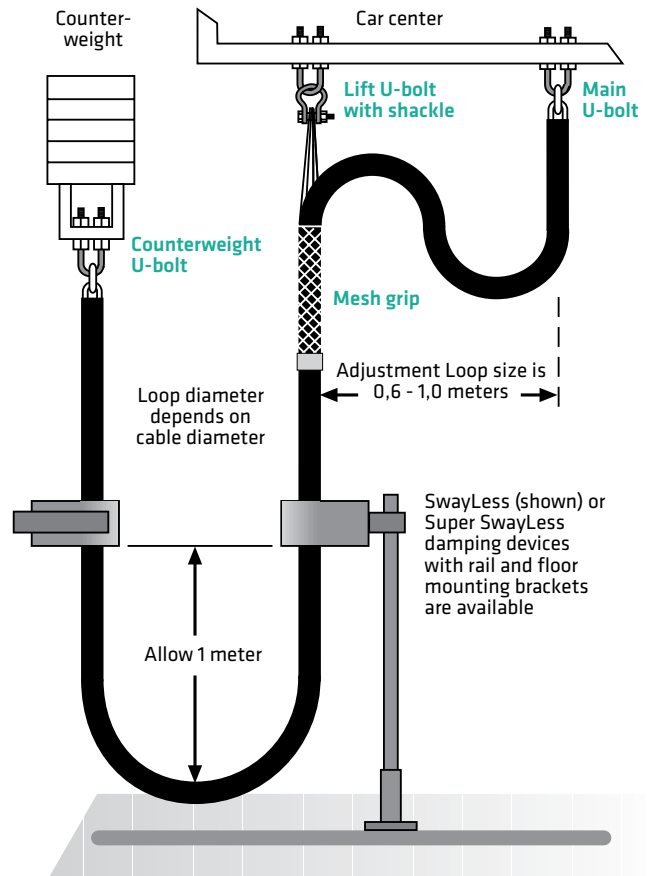

QLII Installation kits for QuietLink II cables (metric components)

Part Number	For Use on Cable	U-Bolt Part No.	Shackle Part No.	Mesh Grip Part No.	Max. Hang Length
IQL10	QL075 & QL10	U-M6	SH-M8	XG04-001	160 m
IQL15	QL125 & QL15	U-M8	SH-M10	XG04-002	130 m
IQL20	QL20	U-M10	SH-M10	XG04-002	160 m
IQL30	QL25 & 30	U-M12	SH-M12	XG04-003	180 m
IQL40	QL35 & 40	U-M14	SH-M14	XG04-004	150 m

These components are specifically designed for the installation of metric compensation cables.

Metric Compensation Cable/Chain Hardware

DESIGNED SPECIFICALLY FOR QUIETLINK II

Steel U-bolt

Part Number	For use on Cables	Dim. A mm	Dim. B mm	Dim. C mm	Dim. T mm	Pin Diameter mm	Min. Breaking Strength (kN)
U-M6	EB050	6,0	120	50	75	1,6	13,818
U-M8	EB075	8,0	120	50	75	2,0	22,246
U-M10	EB10 EB125	10	120	50	75	3,2	36,701
U-M12	EB15 EB20	12	120	50	75	4,0	57,183
U-M14	EB25, EB30, EB35, EB40	14	120	50	75	4,0	74,725

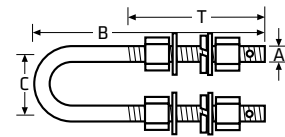

The U-bolt comes with all nuts, washers and cotter pins.

Steel shackle for QuietLink II

Part Number	For use on Cables	Bolt Size mm	Pin mm	Dim. L1 mm	Dim. L2 mm	Dim. A mm	Dim. B mm	Min. Breaking Strength (kN)
SH-M8	QL075 QL10 QL125	M8 x 45	2,0 x 20	12,5	28,5	12	23	22,246
SH-M10	QL15 QL20	M10 x 50	2,5 x 20	12,5	28,5	12	23	36,701
SH-M12	QL25 QL30	M12 x 50	3,2 x 20	12,5	28,5	12	23	57,183
SH-M14	QL35 QL40	M14 x 60	3,2 x 20	18,0	36,0	16	27	74,725

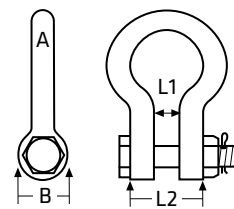

The steel shackle cannot be ordered separately.

Stainless steel mesh grip - Double eye/double weave/closed mesh

Part Number	For use on Cables	Nom. Overall Length in • mm	Min. Breaking Load (kN)
XG04-001	QL075 & 10	710	16
XG04-002	QL15 & 20	710	37
XG04-003	QL25 & 30	710	45
XG04-004	QL35 & 40	710	63

These components are specifically designed for the installation of metric compensation cables.



Easy-Balance™ Compensation Cable

CABLE AND INSTALLATION KITS

Easy-Balance™ chain

Product Code	Chain Weight kg/m	Chain Trade Size (nom. ± 0.5) mm	Chain Nom. OD mm	Max. Hang Length meters	Nom. Loop Width mm
EB050	0,88	6,0	21	180	280
EB075	1,12	7,0	26	180	280
EB10	1,49	8,0	29	180	300
EB125	1,88	9,0	32	180	300
EB15	2,24	10	36	180	300
EB20	2,98	11	39	180	300
EB25	3,73	13	46	180	300
EB30	4,47	14	50	180	320
EB35	5,22	15	53	180	320
1EB40	5,96	16	56	180	320



Easy-Balance chain provides quiet operation at temperatures of -15° C to +60° C, and can be used for elevators with rated speeds of up to 1,75 m/sec. Low carbon chain is coated with a flexible layer of PVC for quiet operation.

No shallow pit kits or special hardware (other than the recommended U-bolts - see below) are required with Easy-Balance compensation chain. Damping devices are not needed.

NOTE: Easy-Balance is not a stocked item - it must be specially ordered.

IEB installation kits for chain compensation

Part Number	For Use on Easy-Balance	U-Bolt Part No.
IEB050	EB050	U-M6
IEB075	EB075	U-M8
IEB125	EB10, EB125	U-M10
IEB20	EB15, EB20	U-M12
IEB40	WF-BS014	U-M14

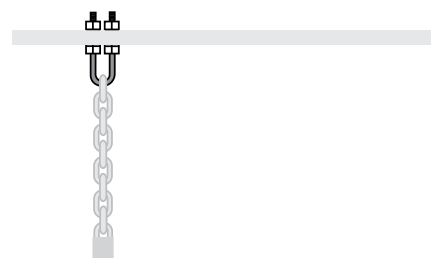

IEB installation kits contain two U-bolts, nuts and washers.

Compensation Cable Accessories

SWAYLESS® AND SUPER SWAYLESS DAMPING DEVICES

US patent 6,234,277, Euro patent 1,177,150

Part Number	Overall Dimensions	Centre opening	Quantity
WF-SRD-M	158 x 100 x 70 mm	70 mm	2
WF-SRD-BR	brass ring replacement	70 mm	1

Two Swayless devices are required per installation. Mounting brackets are sold separately.

WF-SRD Swayless damping devices are recommended for maintaining smooth operation of Whisper-Flex compensation cables for speeds of up to 2,54 m/sec.

The purpose of the WF-SRD is to dampen any oscillation or cable sway that may be generated by cable motion at higher speeds. The damping device is not usually required but can be used for speeds less than 1,78 m/sec. Proper installation requires that compensation cable should not contact the ring of the damping device when the cable is stationary. Cable must be centered within the holes. See installation diagrams on pages 46 and 47 for placement.

The WF-SRD can be used for Whisper-Flex sizes WF075 to WF30 and QuietLink II sizes QL075 to QL30. Draka Elevator offers mounting brackets for easy installation in the elevator pit. Consult the Compensation Cable Installation Guide for the installation of damping devices.

For shallow pits not allowing three feet height above cable loop, please call Draka Elevator for engineering assistance.

Swayless® mounting brackets

Part Number	Description
SL-FMB-48	(2) floor-mounted brackets, adjustable to 1,2 m height
SL-FMB-2	(2) floor-mounted brackets, adjustable to 1,2 m height, includes (2) Swayless devices
SL-RMB-60	Counterweight rail-mounted bracket, adjustable to 1,5 m width
SL-RMB-2	Counterweight rail-mounted bracket, adjustable to 1,5 m width, includes (2) Swayless devices

These brackets are especially designed to help you to quickly and easily install Swayless devices off the counterweight guide rails and off the pit floor. They come with all the necessary hardware, including nuts and bolts.

Super SwayLess®

Part Number	Application	Overall Dimensions mm	Mounting Hole Dia. mm	Quantity
WF-RDD4	Whisper-Flex, Steadi-Flex and QuietLink II cables	203 x 203 x 79	13	1
ISOLATION PADS	Replacement pads	38,1 X 38,1	13	4

The new Super SwayLess WF-RDD4 is designed for use on any size Whisper-Flex®, Steadi-Flex® and QuietLink II™ compensating cable. It is recommended for smooth compensating cable operation for speeds up to 3,56 m/sec.

Larger free-turning nylon rollers have been engineered with a bigger shaft for increased durability. The increased size of the rollers also permits quieter operation. Grease-filled high-strength bearings are built to handle the higher pressures and impact of Steadi-Flex cables.

Super SwayLess mounting brackets

Part Number	Description
SSL-FMB-48	(2) floor-mounted brackets, adjustable to 1,2 m height, order WF-RDD4 separately
SSL-RMB-72	Counterweight rail-mounted bracket, adjustable to 1,8 m width, order WF-RDD4 separately
SSL-RMB-2	Counterweight rail-mounted bracket, adjustable to 1,8 m width, includes (2) WF-RDD4 devices

These brackets are especially designed to help you to quickly and easily install Super SwayLess devices off the counterweight guide rails and off the pit floor. They come with all the necessary hardware, including nuts and bolts.

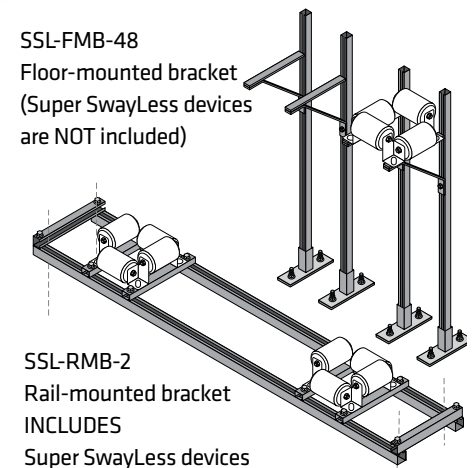
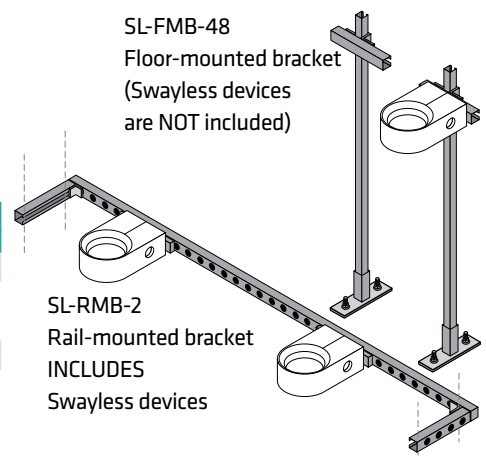

Lubricants

FOR WIRE ROPE, HYDRAULIC RAMS AND ELEVATOR / ESCALATOR GUIDES

Wire rope lubrication

Part Number	Description
CITEACULUB200	ACCULUBE automatic rope lubricator/cleaner kit, with three brushes (210 mm span), bracket and reservoirs filled with DrakaLube wire rope treatment
CITEACULUB300	Like above, with three brushes (300 mm span)

The Acculube automatic rope lubricator/cleaner is a set-and-forget way of efficiently lubricating traction ropes for up to a year. See page 45 for more information.

Wire rope lubricants

Part Number	Description
CITEWRDRAKALUB	DRAKALUBE wire rope treatment / lubricant, 3,8 litres
CITELUWRP320AG	LUBROIL AG320, 5,62 litres
CITELUWRPT86L5	Gustav Wolf T-86 lubricant, 5 litres

These are formulated with selected paraffinic oils, blended with suitable anti-rust and anti-drop additives.

Hydraulic oils

Part Number	Description
CITEHYDRA46L20	REPSOL HIDRAULICO 46, 20 litres, 18 kg
CITEHYDRA68L20	REPSOL HIDRAULICO 68, 20 litres, 18 kg
CITEAVILLIFT46	Hydraulic oil 46, 20 litres, 18 kg
CITELUBHFT68L1	Hydraulic oil 68, 1 litre, 0,88 kg
CITEAVILLIFT68	Hydraulic oil 68 HVI, 20 litres, 18 kg
CITELUBIDVG220	AGIP ARNICA 46, 20 litres, 18 kg

Specially-selected base fluids provide excellent chemical/physical stability while additives improve their ability to withstand heavy workloads.

High-viscosity oils are refined to achieve a high-viscosity index and resistance to oxidation. Special additives improve these characteristics and give these lubricants both anti-wear properties and excellent thermal stability.

Elevator and escalator guide lubricants

Part Number	Description
CITELUAVIRS220	GEAR EP 220, 20 litres, 18 kg
CITELUBSNG220	AGIP BLASIA S220 synthetic, 20 litres, 18 kg*
CITELUTIK150L5	TI OIL K-150 for escalator guides, 5 litres, 4,47 kg
CITELUBSLI68L5	BLUE OIL SLIDING 68, 5 litres, 4,47 kg
CITEOPCATFT205	KLUBER CATENERA FLUID FT 2, 5 litres

Mineral-based lubricants, originally intended for use on industrial gears, are enhanced with the addition of special compounds (such as sulfur/phosphorus) that improve their resistance to extreme pressure.

*Synthetic (PHY) high-performance lubricants include the latest generation additives which make them ideal for use in areas with severe and wide temperature ranges from -30°C to +200°C. They provide protection against corrosion and offer better water separation.

Escalator chain grease

Part Number	Description
CITEGREASEPMP2	ERG GREASE MP EP 2, 4,5 kg
CITEGRAFIPERS1	ERG GREASE MP EP 2, 0,85 kg
CITEOGRASEP25K	OILINE LIGRAS EP 2 MP, 4,5 kg
CITEOGRASEP21K	OILINE LIGRAS EP 2 MP, 1,0 kg

Formulated from selected paraffinic lubricants, supported with lithium soap (hydroxystearate) for extreme pressures. They contain antioxidant additives and corrosion inhibitors.

Traction elevator lubricant locations

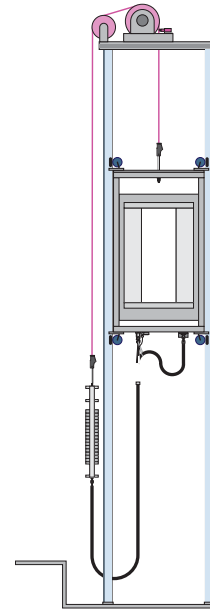

Hydraulic elevator lubricant locations

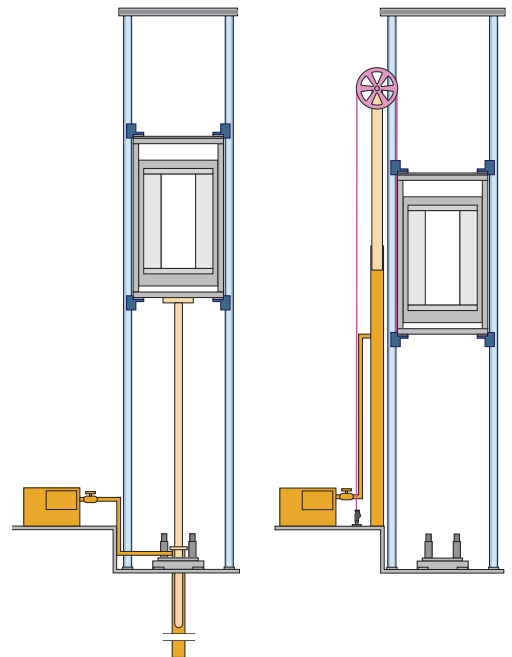

Escalator lubricant locations

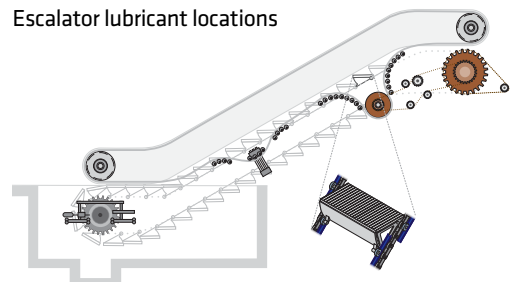

Seismic Detection Equipment

DRK-S701 Event Monitoring Device (EMD) Seismic Detector



Part Number	Description
DRK-S701	EMD seismic detector with relays for external sensors - AC or DC power
30016	Replacement battery for DRK-S701
78-108	Fuse for DRK-S701



The DRK-S701 EMD detects and measures seismic events and signals elevator controls to take appropriate action based on their magnitude. Properly installed, the EMD will detect a potentially dangerous seismic event and alert the controller to stop the car at the nearest floor to discharge the passengers. It can also be connected to the Draka Ring-on-a-String counterweight displacement sensor.

While the EMD is highly flexible and can be configured for various applications, its three main functions are to 1) detect a seismic event and trip a latching and non-latching relay (referenced as an Alarm Event Trigger), 2) detect an internal failure and trip a latching relay (referenced as a Trouble Event Trigger), and 3) detect an event from an auxiliary sensor and trip a latching relay (referenced as an Auxiliary Event Trigger).

Features

- Easy to install - Mount it, level it and turn it on
- Can also be custom programmed
- Auxiliary interface for counterweight displacement device
- Uses either 110/220VAC or 12/24VDC power
- Battery backup time approx. 18 hrs on 1 rechargeable battery and up to 36 hrs on two
- Troubleshoots itself and displays trouble codes
- Economical
- Advanced dual-sensor technology prevents false alarms
- MRL safe - Remote reset and test eliminates hoistway visits

Approvals

Evaluated in accordance with ANSI/ASME A17.1 2013-10-21 and A17.5 2011-03-01.
Also evaluated in accordance with CAN/CSA B44, and B44.1

Counterweight displacement kit (“ring on a string”)

Part Number	Description
CDH-R8	Counterweight displacement kit, mounts to T89 guide rails (order cable [CDH-L500, CDH-L1000 or CDH-L1500] separately)
CDH-R12	Counterweight displacement kit, mounts to T127 guide rails (order cable [CDH-L500, CDH-L1000 or CDH-L1500] separately)
CDH-L500	Cable, 500 ft • 152 m length, 1/16 in. • 1.6 mm diameter, with thimbles and clips (use for up to 250 ft. • 71 m of rise)
CDH-L1000	Cable, 1000 ft • 304 m length, 1/16 in. • 1.6 mm diameter, with thimbles and clips (use for up to 500 ft. • 152 m of rise)
CDH-L1500	Cable, 1500 ft • 456 m length, 1/16 in. • 1.6 mm diameter, with thimbles and clips (use for up to 750 ft • 223 m of rise)
040219	Cable, cut to length, does not include attachment hardware, please specify length
79-103	Thimble, for 1/16 in. • 1.6 mm cable attachment (replacement part)
79-104	Wire rope clip, for 1/16 in. • 1.6 mm cable attachment (replacement part)
36-178	Wire cutters, for cutting steel cable

The Counterweight Displacement Kit is an easily installed “ring on a string” hardware kit that, when used in conjunction with a relay circuit (not included), can signal the controller if a counterweight has been displaced due to a seismic event.

Two steel cables run parallel to the counterweight guide rails and pass through a pair of eyebolts located on the counterweight. If an eyebolt contacts a cable (which indicates a counterweight displacement), the circuit is completed and the controller stops and redirects the car immediately.

Order one kit and one cable per elevator - the kit attaches to BOTH counterweight rails (as shown). Note that the kit is specified for the rail size and the cable ordered should be at least twice the rise of the elevator - the cable will be cut and installed on both rails.

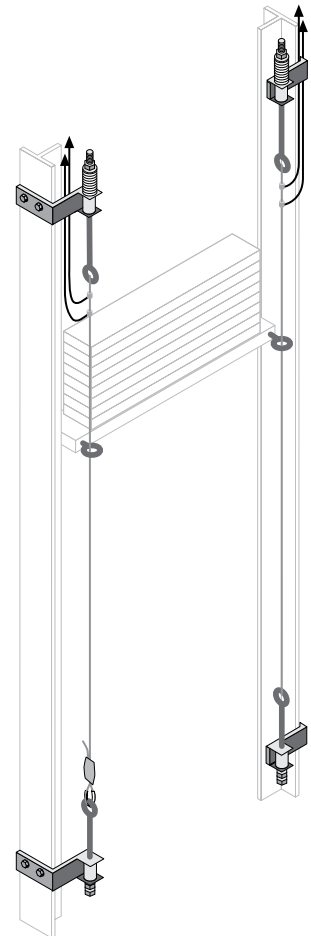

Emergency Communications Systems

TO MEET EN 81-28, EN 81-70, EN 81-80, AND A17.1 2010 & 2013

Lift1 communicator

Part Number	Description
CCZ2NLIFT1_2	Lift1 communicator, wall-mounted module, for wired connection to any telephone network (PSTN/PBX/GSM), 100 x 185 x 16 mm
CCZ2NLIFT1_1	Lift1 communicator, circuit board for mounting behind control panel, for wired connection to any telephone network (PSTN/PBX/GSM/UMTS), 65 x 130 x 24 mm

The Lift1 emergency communication system is a hardwired communicator that can be placed in the elevator cab either on the wall or behind the car operating panel. It is set up by call-in with simple voice menu. Optionally it can be setup and upgraded via a USB connection. For instance, you can change the language of the voice menu directly from your computer.

The Lift1 can also be upgraded to communicate also from the roof of the cab or the area underneath the cab. Communication between cabin and machine room is also available as an option. Using only a dual-line telephone cable (for power and communication), the Lift1 easily connects the lift communicator to any telephone network (PSTN/PBX) or to the mobile network (GSM/UMTS) when connected to the EasyGate PRO (other features available when using the EasyGate PRO - see page 55).

Features:

- Option of connection via PSTN/PBX/GSM/UMTS
- Option of two-way communication between the machine room and the cabin
- Option of adding communication from the roof of the cabin and underneath the cabin
- Fully powered by a telephone line
- USB port and utility software for more user-friendly programming
- 6 telephone numbers for emergencies
- Full support for CPC and P100 protocols

Lift1 communicator



Lift1 communicator circuit board

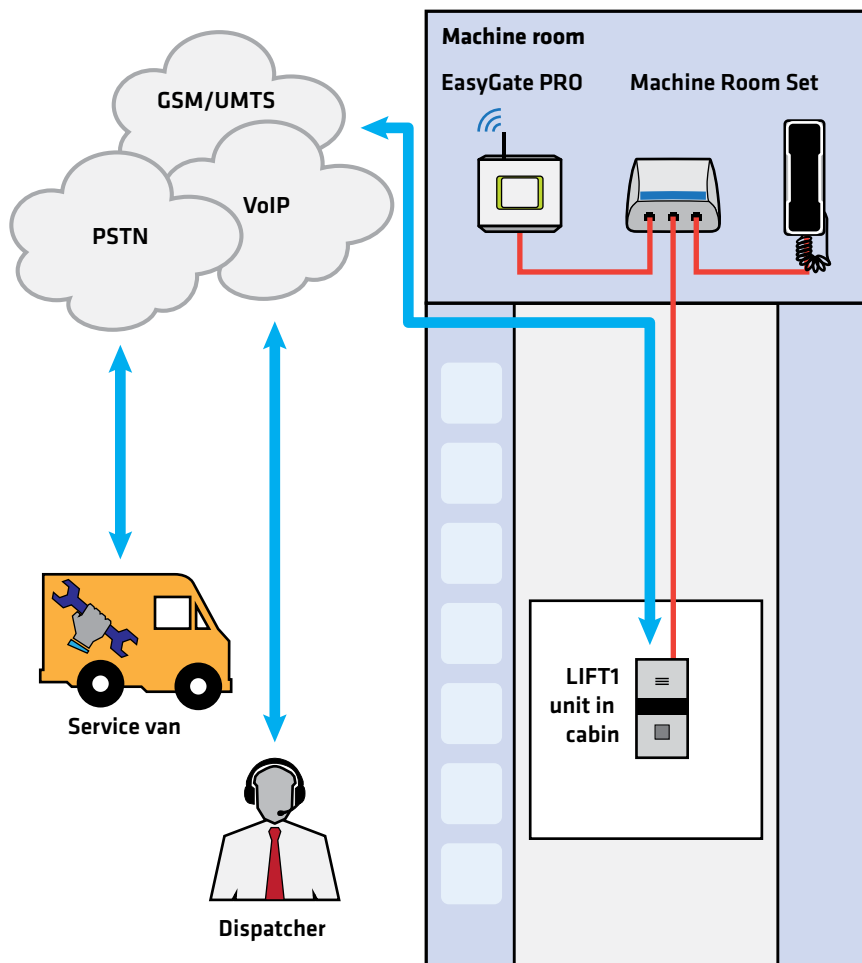
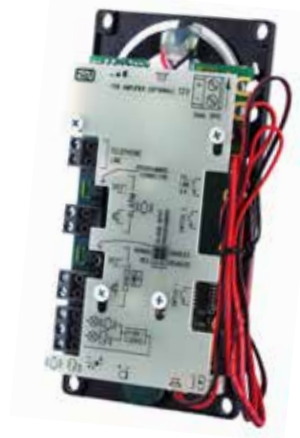

Emergency Communications Systems

TO MEET EN 81-28, EN 81-70, EN 81-80, AND A17.1 2010 & 2013

EasyGate PRO GSM/UMTS communication system

Part Number	Description
CCZ2NACCESSORIES_1	EasyGate PRO, for communication to call center via cellular signal

The EasyGate PRO is an analogue gateway suitable for installation in a lift environment. Not only can you connect it to any emergency lift communication system, but you can also use it for the immediate replacement of a costly landline.

The EasyGate PRO GSM/UMTS gateway is set up at the factory. You don't have to program anything and you can start to use it immediately. It has a signal strength indicator and, thanks to a back-up power supply, is resistant to power outages. What's more, in addition to calls, it can transfer data and send text messages and automatically sends critical information SMS to a pre-defined number.

Features:

Immediate landline replacement results in no monthly landline costs

Back-up power supply

Text messages in case of power outage

Plug & play installation

Voice calls over GSM/UMTS

Caller identification from GSM/UMTS (FSK CLIP)



Lift1 accessories

Part Number	Description
CCZ2NLIFT1_3	Machine room set
CCZ2NLIFT1_5	Top and undercabin communications set
CCZ2NLIFT1_4	USB programming tool



Emergency Communications Systems

TO MEET EN 81-28, EN 81-70, EN 81-80, AND A17.1 2010 & 2013

Lift8 communicator for up to eight lifts

Part Number	Description
CCZ2NLIFT8_1	Lift8 communicator central unit, connecting up to eight audio units, and transmitting communication by PSTN, PBX, GSM, or VoIP, 300 x 170 x 72 mm
CCZ2NLIFT8_9	Lift8 splitter, hub for up to five audio units for connection to the central unit, 142 x 98 x 34 mm
CCZ2NLIFT8_10	Lift8 I/O module
CCZ2NLIFT8_4	Lift8 audio unit for elevator cabin
CCZ2NLIFT8_5	Lift8 audio unit for elevator cabin, compact version
CCZ2NLIFT8_8	Lift8 audio unit for shaft
CCZ2NLIFT8_7	Lift8 audio unit for machine room
CCZ2NLIFT8_11	Lift8 video camera module
CCZ2NLIFT8_6	Lift8 fireman unit

The Lift8 communication system connects up to eight elevators to a central unit. The rugged audio units can communicate to any location over PSTN, PBX, GSM or VoIP. The audio units can be placed anywhere in the cab or shaft for connection to another Lift8 audio unit, the splitter hub or the central unit.

Installation could not be simpler. It uses two-wire cabling already in place. No additional cable is needed.

Features:

- Connects up to eight elevators to a central unit/telephone line
- Simple installation with no unnecessary cabling (just a two-wire bus)
- Communication interface of your choice (GSM/UMTS/PSTN/VoIP) - order separately
- Maximum modularity
- Conference call between all units in one shaft
- Easy and comfortable operation
- SW apps for remote system administration
- Own call center SW application as an option

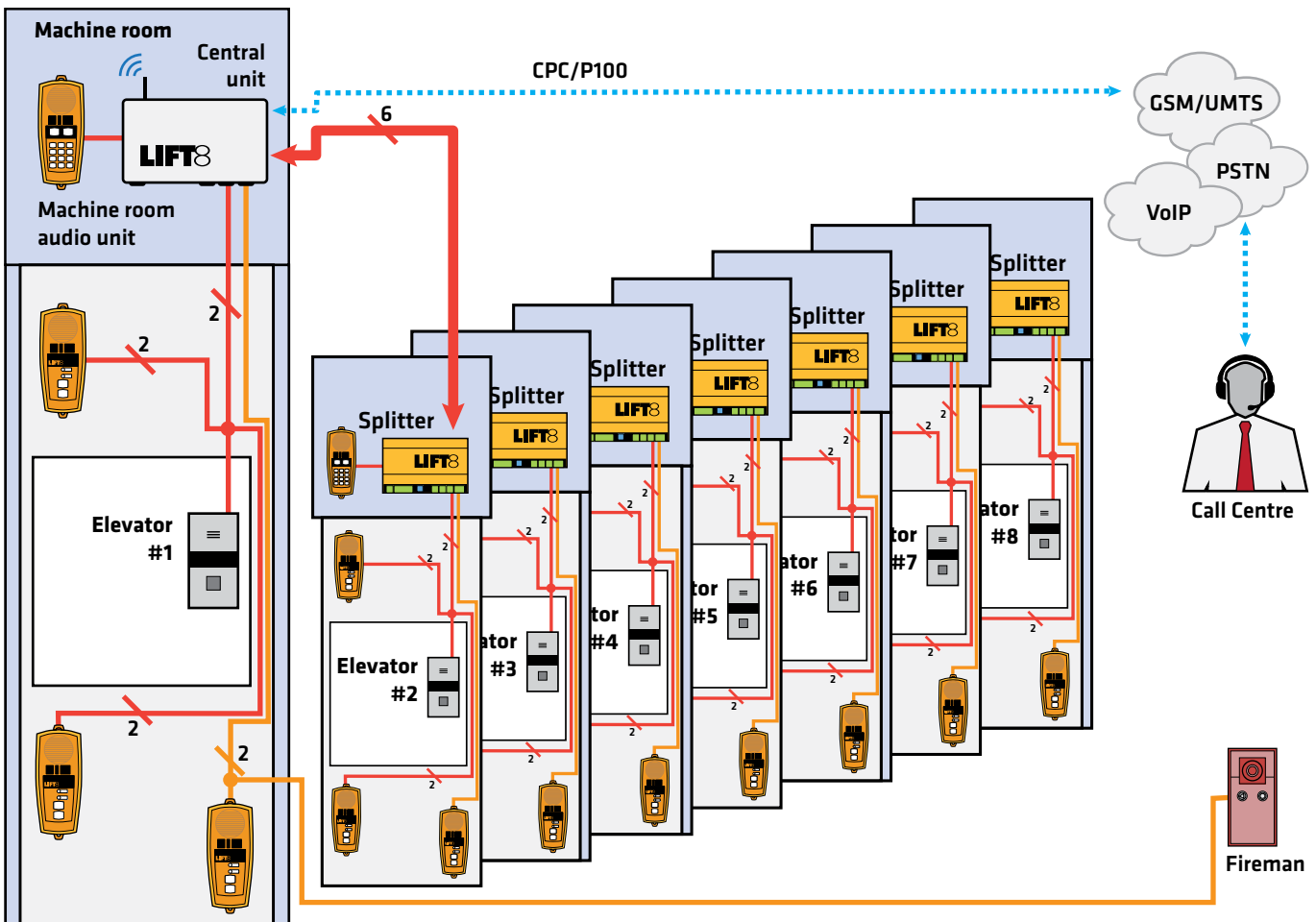

Communications Accessories

2Wire converter

Part Number	Description
CCZ2NACCESSORIES_5	2Wire universal converter, 40 x 40 x 75 mm

The 2Wire converter allows you to use existing two-wire or coaxial cabling in the travelling cable to connect any IP equipment. No additional connectors are required. Attach a 2Wire unit at each end of the cable. Power is required for only one of the units. The 2Wire unit then provides PoE power not only to the second converter, but to all other connected equipment.



Induction loop for hearing assistance

Part Number	Description
CCZ2NACCESSORIES_4	Universal Induction loop with amplifier and antenna, 144 x 100 x 31 mm

The Induction Loop is an electric device that transmits sound wirelessly to the hearing aid. When connected to an audio source, it allows people with a hearing disability to hear much more clearly. Installing an induction loop in the cabin helps compliance with required regulations and allows hearing aid users to communicate via the intercom. The Induction Loop is an invaluable aid for resolving accessibility of public and private areas. It comes with a 4 m antenna.



Floor annunciator

Part Number	Description
CCZ2NACCESSORIES_3	Annunciator, 80 x 90 x 25 mm

The floor annunciator informs passengers on what floor they have stopped, the direction the elevator is going, warns of closing and opening doors as well as overloading of the cabin. The unit is pre-programmed for several languages. Other messages, such as welcomes and advertisements, may be recorded onto the unit. The annunciator meets EN 81-70 and 81-80.



Connectorizing services

Draka Elevator helps you to work smarter with cable that comes ready to install. Provide us with your diagrams and Draka Elevator products will fit hoistway cables, travelling cables and stationary wiring with modular connectors that simply snap into place. We also offer cut-to-length cables and ropes, provide stripped cables and custom assemble inspection and pendant stations.

Draka Elevator Products engineered solutions ensure that cables and harnesses are quickly, easily and accurately installed. Color-coded connectors assure positive circuit identification. All connectorized cable products are 100% post-fabrication tested for total customer satisfaction.

