



Super-Flex[®] Traveling Cable Installation Guide

VERSION 1114



A brand of the

Prysmian
Group

Important! Please read!

WARRANTY AND SAFETY INFORMATION

SUPER-FLEX® traveling cable is designed to be used in most vertical transportation applications. This guide has been prepared to instruct installers in the safe and efficient installation of Super-Flex traveling cable.

If you have any questions regarding installation procedures, please do not hesitate to call Draka Elevator Products at 877 408 HELP (877 408 4357).

Failure to follow these procedures will not only invalidate product warranty but could endanger public safety.

Recommended hanging lengths:

Jute center cables are for
61 m • 200 ft or less

Steel center cables are required for
lengths greater than 61 m • 200 ft

Never exceed maximum recommended hanging lengths.

Recommended operating temperature ranges:

Standard PVC jacketed cables are for
5° F to 140° F (-15° C to +60° C)

Polyurethane (PUR) jacketed cables
are for -4° F to 140° F
(-20° C to +60° C)

If operating below 32°F (0° C), call us
for assistance.

Super-Flex, the Draka globe design and Draka Elevator are trademarks of Prysmian.

Unauthorized reproduction, disclosure or distribution of copies by any person of any portion of this work may be a violation of Copyright Law of the United States of America and other countries, could result in the awarding of statutory damages of up to \$100,000 (17 USC 504) for infringement and may result in further civil and criminal penalties.

Draka Elevator reserves the right to improve, enhance, or modify the features and specifications of Draka products without prior notification.

©2014 Draka Elevator.

All rights reserved. Printed in USA.

FOR TECHNICAL ASSISTANCE,
CALL TOLL FREE (US AND CANADA)
877.408.HELP (877.408.4357)

TO ORDER KITS/PARTS,
CALL TOLL FREE
877.DRAKA EP (877.372.5237)

Draka Elevator
2151 N. Church Street | Rocky Mount, NC 27804
1-877-DRAKA EP (877-372-5237) | +1-252-984-5100 | Fax +1-252-972-6001
Technical information 1-877-408-4357 | www.drakaelevator.com

Initial inspection

LOOK FOR OBVIOUS DAMAGE

Inspect the cable immediately upon arrival.

A cut or gash in the jacket could mean an unsafe cable. Damaged reels or boxes are a sign of rough handling in transit and may indicate cable damage.

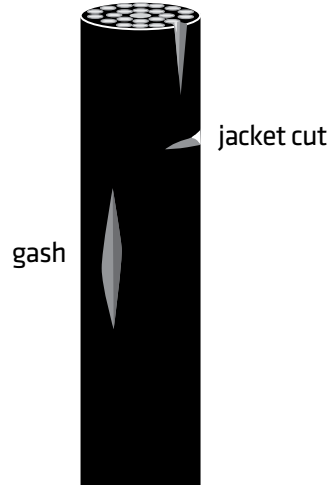

Do not install potentially damaged cable. Call Draka Elevator immediately if you have any questions regarding damaged cable.

Draka Elevator offers complete kits with all of the components necessary to safely install Super-Flex®. Call 877.372.5237 or 252.984.5100 for details.

Super-Flex with steel center

MUST BE USED IF THE SUSPENDED LENGTH EXCEEDS 61 M • 200 FT

Super-Flex steel center cables are required for use in installations where the suspended length of the cable exceeds 61 m • 200 ft (NEC Article 620-41) although they may be used for shorter runs. Do not exceed the cable's maximum hang length as shown in the Draka catalog.

They are supported by their steel centers in a Draka Universal Hanger and secured by clamps around their jackets.

Use of the Draka Universal Hanger is strongly recommended with steel center Super-Flex.

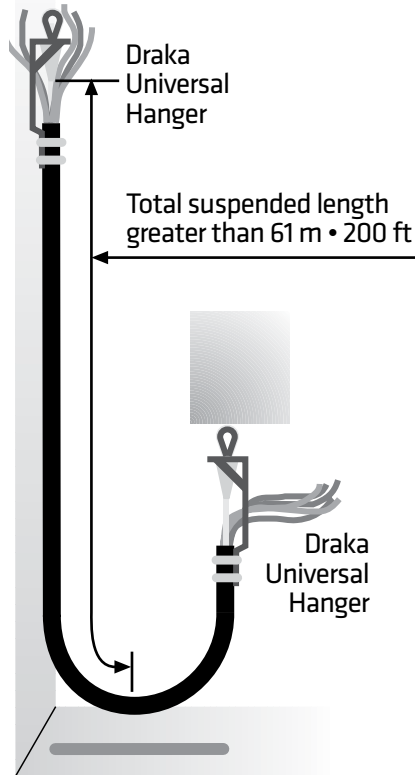

Super-Flex with jute center

MAY BE USED IF THE SUSPENDED LENGTH IS < 61 M • 200 FT

Super-Flex jute center cables are designed for use in installations where the suspended length of the cable is up to 61 m • 200 ft (NEC Article 620-41).

They are supported by self-tightening mesh grips. Always secure the lower end of the grip with electrical tape or a stainless steel hose clamp.

Do not let the cable bend within the grips. Make sure the grips hang vertically.

If you are working in a shallow pit (such as a hydraulic), use shorter double-eye mesh grips.

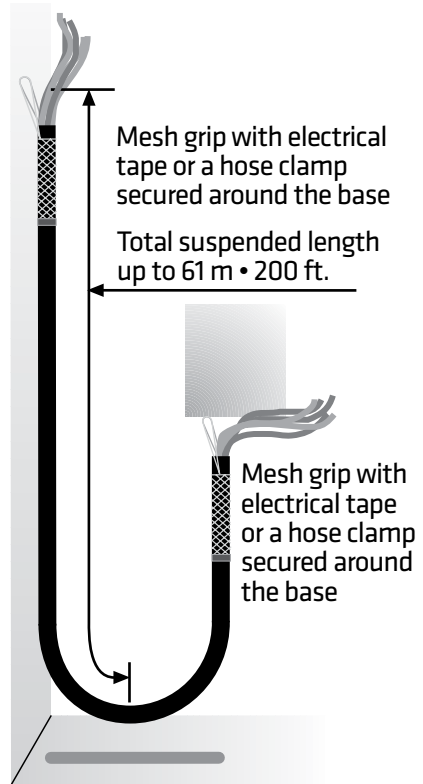

Be sure to use the properly sized mesh grip. Call DRAKA for recommendations.

Transporting the reels

MOVE AND STORE CABLE SAFELY

Super-Flex cable may be moved by forklift.

Lift the reel by the wood, not by the cable.

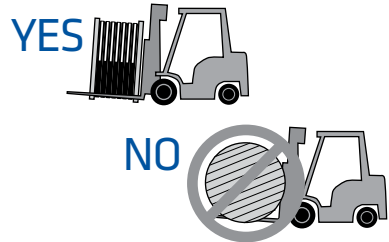

The reel may be rolled on a firm surface.

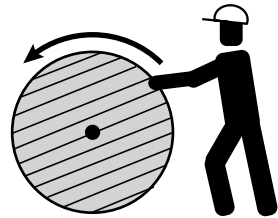

If a hoist is being used, place a strong rod through the reel and lift it by that.

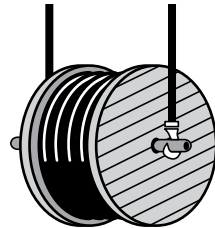

Store the cable in a clean, dry area.
Seal the cable end with electrical tape to keep moisture from entering.

Prepare the cable end

MEASURE AND MARK THE STRIPPING POINT

Determine how much jacket you need to remove in order to have enough exposed conductors to meet their termination points. Most installations require 2 m • 6 ft. or more.

Wrap a band of electrical tape around the cable at the cutting point to act as a guide.

Mesh grips are used to permanently support jute center cables and are used to hoist steel center cables during pre-hanging.

Place the grip about 1.3 m • 4 ft. below the tape wrap. Secure the base of the grip with several windings of electrical tape or a hose clamp.

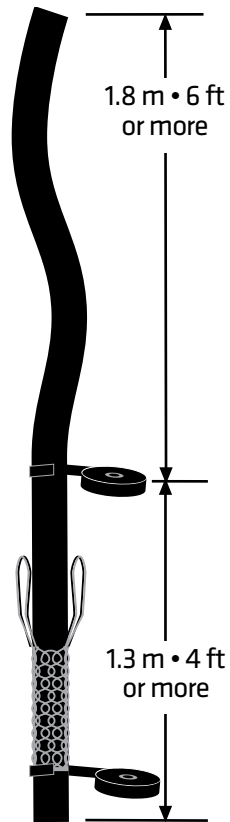

Be sure to use the properly sized mesh grip. Call DRAKA for recommendations.

Prepare the cable end

REMOVE THE JACKET

Clamp the cable in a vise or place it on the floor. Using a Flexi-Peeler® (Draka #36-060) or a razor knife, make an orbital cut through the jacket at the tape. Avoid nicking or cutting the conductor insulation.

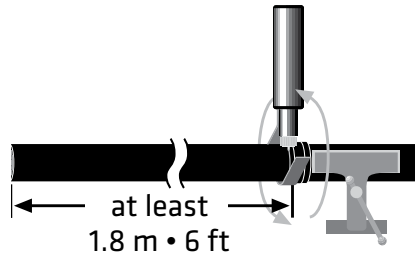

Cutting away from yourself, slit the jacket from the electrical tape to the cable end. Peel away the jacket.

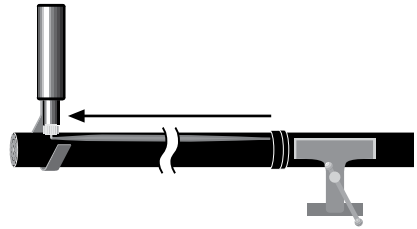

A Super-Peeler® (Draka #36-146) may also be used to remove the jacket. Adjust the cutting depth by turning the dial. Make an orbital cut and then adjust the head 90° to make the lengthwise slit.



Prepare the cable end

REMOVE THE FILLER AND EXPOSE THE CONDUCTORS

Remove the braid with the Sock Slicer (Draka #36-177). Other methods include using medical scissors or making short, light strokes with a utility knife. Be careful not to nick any of the conductor insulation.

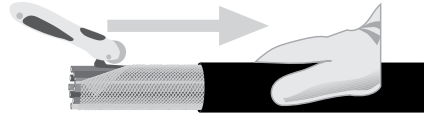

Separate the jute fillers from the conductors layer by layer as you move from the end of the cable.

Use scissors or wire cutters to remove the excess jute.

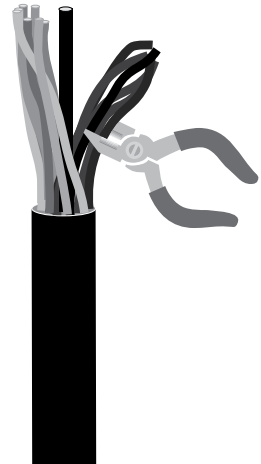

Prepare the cable end

BIND THE CONDUCTORS FOR EASIER HANDLING

For steel center cables, keep the steel center separate from the conductors. Cut off all but 43 cm • 17 in. to 51 cm • 20 in. of the steel center.

Remove most of the steel center's insulation, leaving at least 5 cm • 2 in. of the insulation at the base of the bundle.

Bind the conductors tightly together with tape to aid handling.

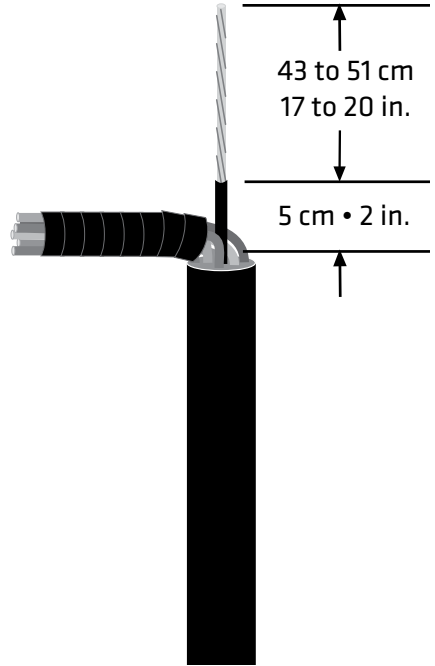

Mid-cable entry

REMOVE (BUT SAVE) THE JACKET

If you are using Super-Flex without Super-Duct® hoistway cable (see page 23), a hanging device will be needed at the cable mid-point.

(1) Mark the desired support point with electrical tape. This will be the point where the steel is pulled out to support the cable left hanging down the shaft.

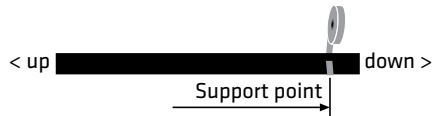

(2) Place another mark on the cable one meter up from the support point. This is where the steel core will be cut.

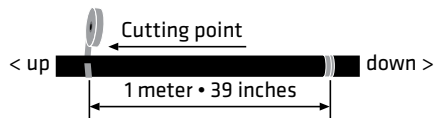

(3) If you are unfamiliar with the Flexi-Peeler (Draka #36-060), read the enclosed instructions to familiarize yourself with the operation of the tool.

At one end of the cable, compare the blade depth to the thickness of the jacket. Set the blade for just under that depth. The Flexi-Peeler is used to make a shallow cut into the jacket so that the jacket can easily be peeled apart by hand without damaging the conductors. The blade should not be allowed to penetrate all the way through the jacket.



Mid-cable entry

REMOVE (BUT SAVE) THE JACKET

(4) Use the Flexi-Peeler to make a full circular cut around the diameter of the cable at the cutting point. DO NOT cut all way through the jacket.

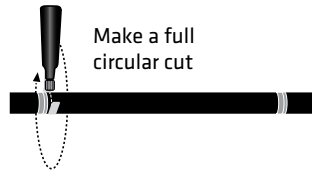

(5) Rotate the Flexi-Peeler 90° and pull the tool down the cable to the support point making a full linear cut.

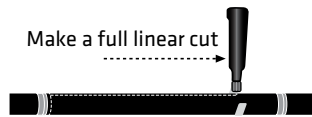
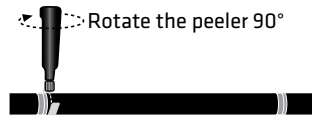

(6) Rotate the Flexi-Peeler -90° to its original position and make a full circular cut in the cable at the support point.

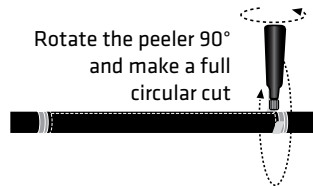

(7) You should now be able to flex the jacket causing it to crack all way through. Peel it away from the cable.

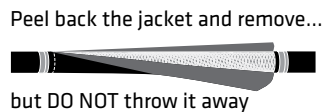

DO NOT discard the jacket once peeled away. It will be used to cover the conductors after the steel core has been pulled out.

Mid-cable entry

EXPOSE THE CONDUCTORS AND STEEL SUPPORT

(8) If you are unfamiliar with the Sock Slicer, read the enclosed instructions to familiarize yourself with the operation of the tool.



Insert the narrow plastic 'needle' portion of the Sock Slicer under the braid. Use caution not to get it under any conductors. Slide the Sock Slicer along the length of the stripped cable to remove the braid. The Sock Slicer may also be used to remove the binder from the cable.

Use the Sock-Slicer to remove the braid and binder



(9) Make a slight bend in the cable while slightly twisting to relax the lay of the conductors and filler.

Bend the cable to relax the lay of the conductors



(10) Gently open up the lay to expose the inner steel core.

Gently spread the conductors to expose the steel core



Mid-cable entry

EXPOSE THE CONDUCTORS AND STEEL SUPPORT

11) Just below the upper mark on the cable, use steel cutters to cut the core. Be careful that no conductors are cut or damaged in the process.

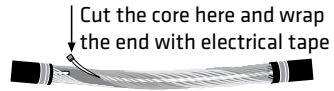

(12) Wrap the ends of the cut steel core with electrical tape to prevent the exposed steel from damaging the inner conductors.

(13) Starting at the upper mark where the core was cut, gently work the steel core out of the cable. Pull the core out from the center of the cable back to the point of the lower mark.

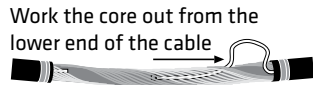

Pre-hang the cable

DETERMINE YOUR PRE-HANGING POINT

Choose a secure point in the hoistway (usually above the mid-hoistway junction box at near the top of the hoistway) that will allow the entire length of the cable to hang without touching the wall or floor.

This is the pre-hanging point.

If it is not possible to pre-hang the cable without it touching the floor of the pit, use the alternate method described on pages 18 - 20.

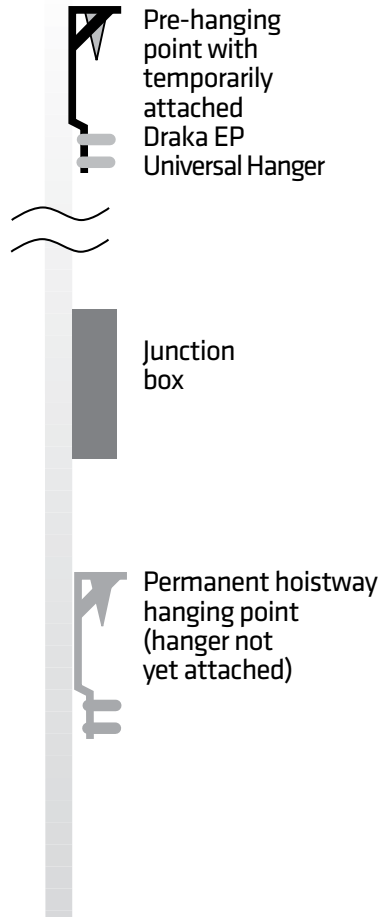

Pre-hanging is essential for the smooth operation of traveling cable. Failure to pre-hang the cable will affect performance.

Pre-hang the cable

DETERMINE YOUR PRE-HANGING POINT

For steel center cables, *temporarily* bolt or otherwise attach the proper-sized Draka Universal Hanger at the pre-hanging point to a secure location in the hoistway (wall, structural member, etc.)

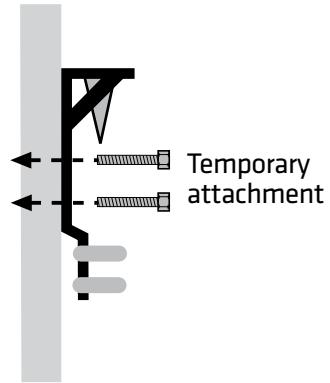

For jute center cables, locate a place where the eyes of a double-eye mesh grip can be securely attached.

Install the cable: preferred method

USE THE CAB TO RAISE THE REEL TO THE PRE-HANGING POINT

Prior to unreeling the cable, remove any hoistway obstructions that may be in the cable path. If they cannot be moved, pad them to avoid abrasion.

Place the reel on reel rollers or jack-stands in the car.

Make sure the reel can rotate freely.

Move the cab up to the pre-hanging point.

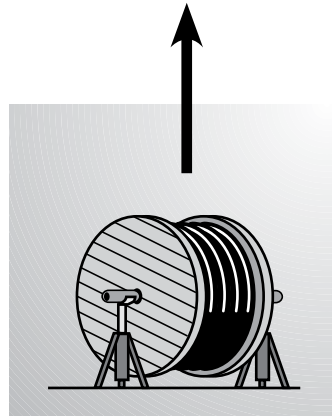

Install the cable: preferred method

ATTACH THE CABLE TO THE PRE-HANGING POINT

The cable core and jacket **MUST NOT TWIST** during pre-hanging.

For steel center cables, run the steel center through the strand vise until it protrudes about 20 cm • 8 in. from the top of the vise.

Do not let the conductors get trapped between the steel center and the hanger.

Set the vise by pulling down on the cable. Tighten the hose clamps to secure the cable. Pass the steel center through the fender washer and bend it around the thimble (where provided). Secure it at the base with a wire rope clip to form a cable stop.

For jute center cables, use a double-eye mesh grip to support the cable. Keep the eyes on opposite sides of the cable to prevent twisting.

The base of the grip should be secured by several wraps of electrical tape.

Use the proper size and style of grip.

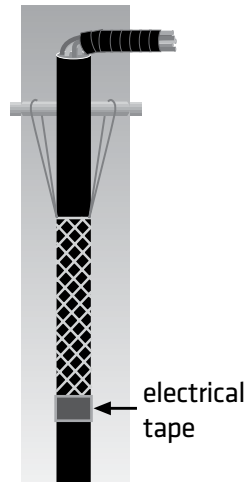
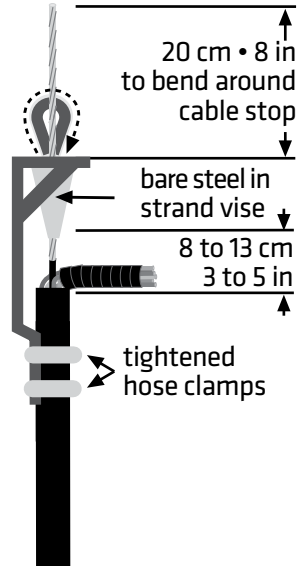

Install the cable: preferred method

LOWER THE CAB TO PAY OUT THE CABLE

Slowly lower the cab while paying the cable out the top or side of the car. Pay the cable out from the bottom of the reel to minimize stress.

The cable end should now be hanging freely from the pre-hanging point and at least 30 cm • 1 ft above the floor of the pit.

Allow the cable to hang and “relax” for 24 hours.

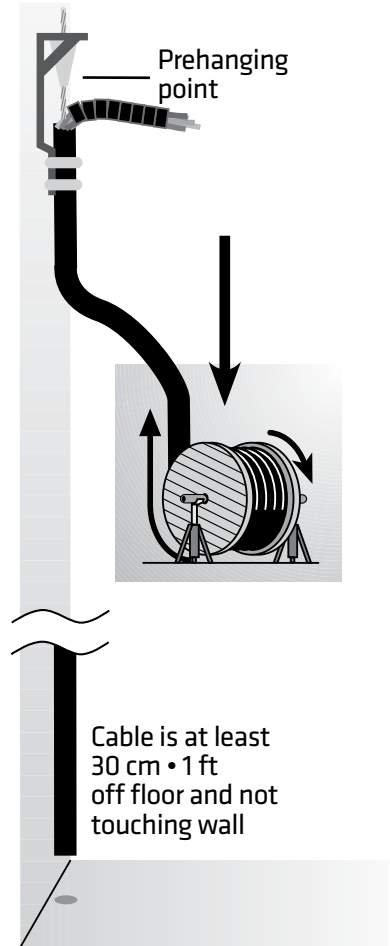

Note: If paying out coils (Instead of a reel) of Super-Flex, uncoil it as if it were on a reel, rotating it with your hands.

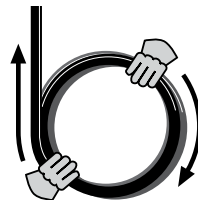

Install the cable: alternate method

USE THE CAB TO RAISE THE CABLE

Locate and prepare your pre-hanging point as outlined on pages 13 - 14. You should have already placed on the prepared cable end a mesh grip and secured it with tape (see page 5). If you have not, do so now.

DO NOT tie a rope or wire around the cable as this could crimp and damage the conductors.

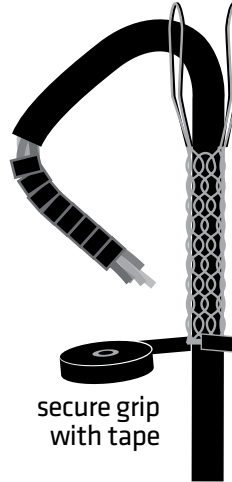

Place the Super-Flex reel on the floor of the pit or on the lowest landing. Make sure the reel can rotate freely. Pay the cable out from the bottom of the reel.

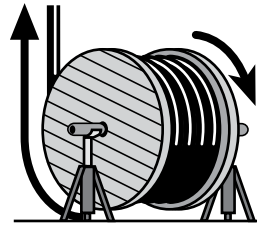

Be sure to use the proper grip for your application.

Install the cable: alternate method

USE THE CAB OR HOIST TO RAISE THE CABLE

Attach the cable to the outside of the car by the eyes of the mesh grip and raise it to the prehanging point. The cable may also be taken up to the prehanging point with a hoist.

If the cable will be permanently supported by a Draka Universal Hanger, it is recommended that the mesh grip be of stainless steel double-eye, double-weave design of either the split-laced or split-rod construction.

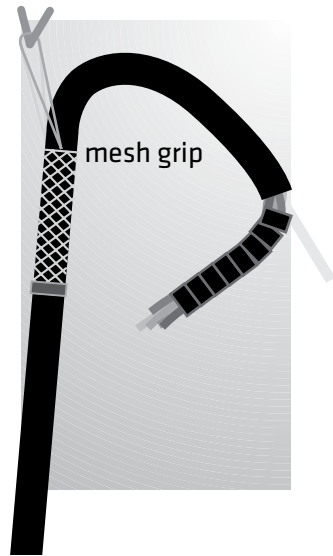

If your installation requires an alternate installation method to lower the cable down the hoistway, call DRAKA'S Application Engineering department at 877.408.4357 or 252.984.5100.

Alternate method to “relax” the cable

IF STANDARD PRE-HANGING IS NOT POSSIBLE

If it is not possible to pre-hang the cable without it touching the floor of the pit, attach the cable securely at its permanent termination point using the Draka Universal Hanger or a mesh grip.

Make a loose noose with a light rope and pull the cable away from the wall so as to permit proper orientation of the cable.

Loop the cable back up the hoistway and tie it off to itself. Make sure the bottom of the loop is at least 30 cm • 1 ft from the floor of the pit. Allow the cable to hang and “relax” for 24 hours.

After 24 hours, untie the cable end. Avoid twisting the cable when you install it on the car. Mark the pre-hung cable.

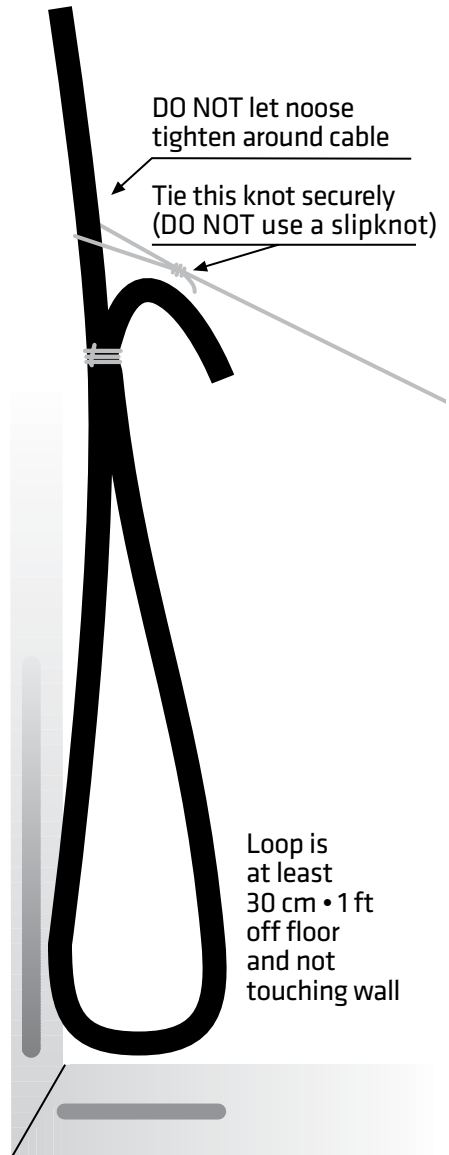

Mark the pre-hung cable

PREVENT TWISTING WHEN TERMINATING THE CABLE AT THE CAB

If you have used the preferred pre-hanging method, use a grease pencil or white-out to mark the hanging end of the cable with a straight line several feet in length.

This will be used for reference to keep the cable from twisting during attachment to the cab.

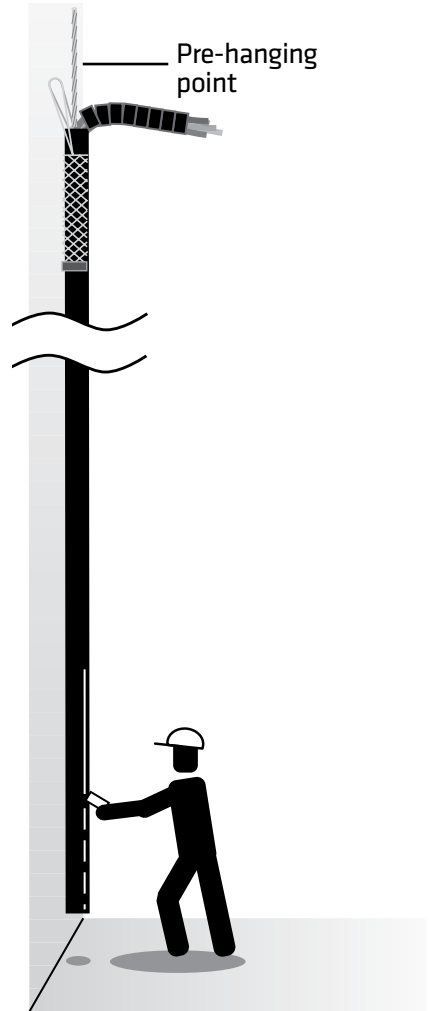

DO NOT use the manufacturer's markings as guides for the orientation of the cable.

Move the pre-hung cable

INSTALL THE CABLE AT ITS PERMANENT TERMINATION

Move the cable to its permanent hoistway hanging point.

For long, heavy runs of cable, it is recommended that you first attach the grip to the cab with a strong line.

You may then detach the grip from the hoistway wall and move the cab down to the termination point.

Keep the cable from twisting or coiling as it moves downward in the hoistway.

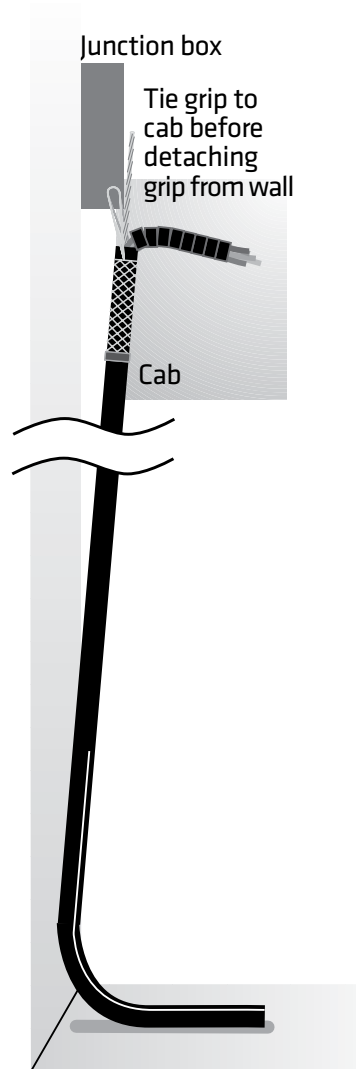

Mid-hoistway grip

SOMETIMES USED WITH JUTE-CENTERED CABLES

Super-Flex may be routed directly to the motor room. With longer jute center cable runs, an additional grip may be placed just above the hoistway midpoint to help support the weight of the cable.

The mid-hoistway grip must be at least 15 cm • 6 in above the uppermost moving point of the cable.

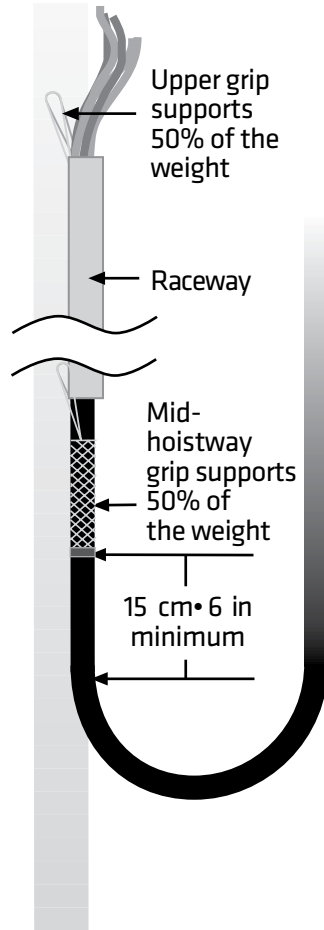

Determine loop diameter

PREPARE THE CABLE FOR CAB ATTACHMENT

The loop diameter is the centerline distance between two parallel cable legs when the cable is raised underneath the cab. This distance determines the position of the termination point on the cab.

Multiply the cable diameter by 30. The size of the loop diameter should be within 10% of that figure. Adjust the cable so that the ends of the loop remain parallel.

Prepare the cable end for termination as before, stripping away the jacket, braid, binder, jute, excess steel core and insulation.

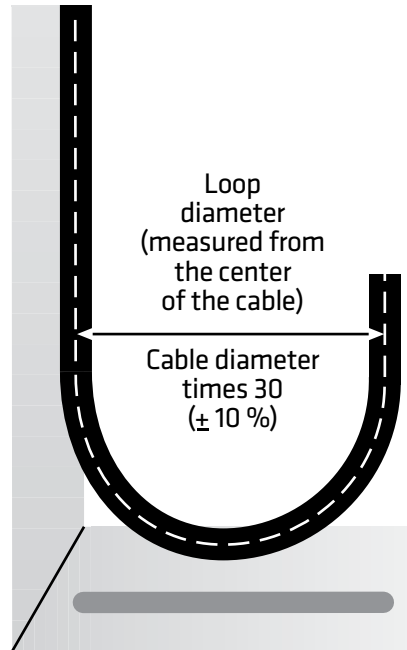

Attaching cable to cab

MEASURE BEFORE YOU SECURE THE CABLE

Bring the elevator cab down until the buffer is compressed. The cab attachment point should be on the same plane with the hoistway attachment point.

Attach the cable at the car hanging point using the proper hanging device (mesh grip or Universal Hanger). Use the marked line as a guide to insure proper orientation of the cable and to prevent twisting.

Adjust the hanger location to get the correct loop diameter. The loop bottom must be at least 15 cm • 6 in from the floor. The loop curvature must start at least 15 cm • 6 in from the base of the hanger or grip. The hanger should be facing the loop. Once the loop is correctly sized and positioned, secure the cable with either hose clamps (Universal Hanger) or electrical tape (mesh grip).

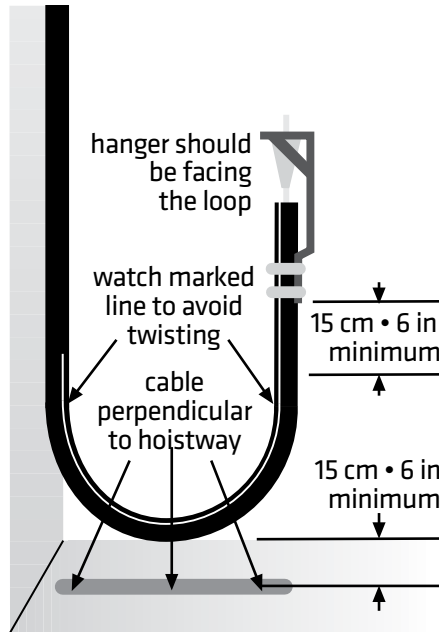

Correcting problems

ELIMINATE BELL-OUT AND OFF-PLANE OPERATION

Properly prehung and installed Super-Flex will maintain a U-shaped loop perpendicular to the wall from which it hangs.

Should the cable 'bell out,' the cab attachment point has to be moved farther from the hoistway attachment point.

Recalculate the loop diameter and move the cab hanging point accordingly.

Should the cable shift off-plane, the cable needs to be relieved of installation stress.

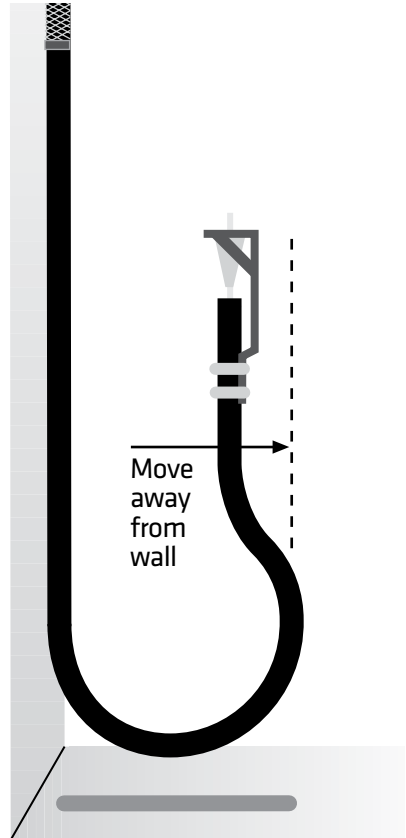

Looking up from the bottom of the cab, if the cable is bent to the side, loosen the grip on the cab end of the cable and twist it until it relaxes and hangs vertically, then re-secure the cable

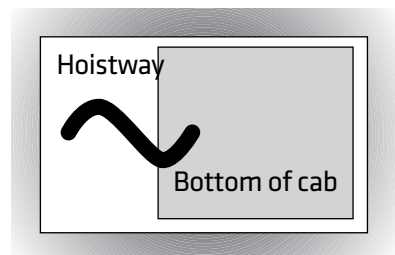

Multiple cable installations

NOTES ON USING DIFFERENT SIZE CABLES

Use cables of the same diameter whenever possible. Install them with the same loop diameters.

If using cables of different diameters, adjust your cab attachment points accordingly.

Make sure the smaller cable (with the smaller loop diameter) hangs below the larger one.

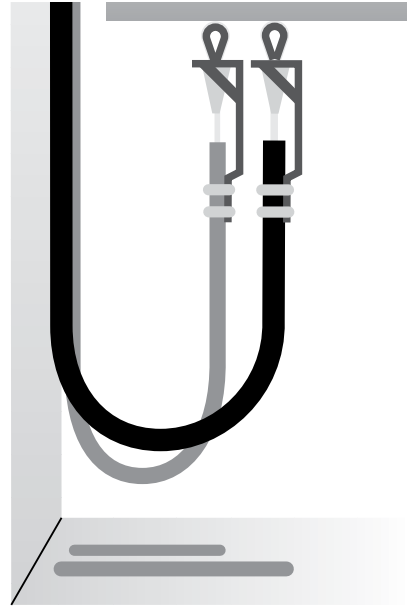

Final inspection

CHECK ALL POINTS PRIOR TO OPERATION

A routine inspection program should be implemented to maximize product safety and performance.

Give your installation a final inspection.

Make sure that:

- the cable is protected - remove all obstructions that may come in contact with moving cable. Use beam pads and/or HOSS (Hoistway Obstruction Shield System) where needed.
- the cable hangs vertically and freely.
- the cable has not been nicked or cut during installation.
- all termination points are secure.
- all mesh grips are secured at their bases with electrical tape or hose clamps.
- the cable does not bend inside a cable grip.
- if using Draka Universal Hangers, the strand vise is seated firmly in its bracket and bears the weight of the cable. Do not over-tighten the cable clamps as that may damage the cable.